

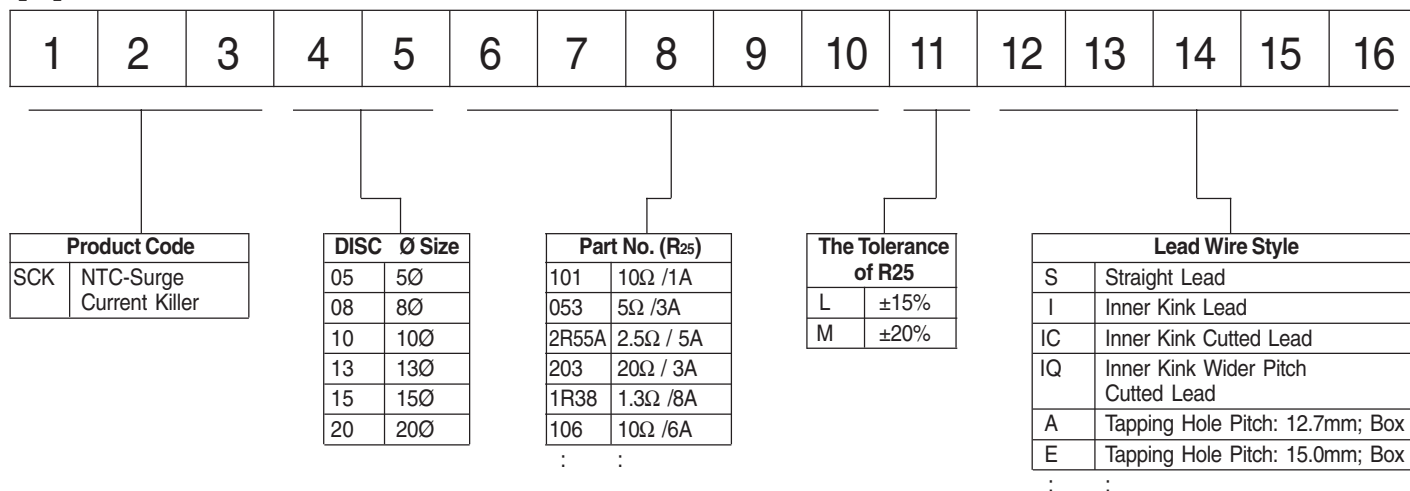

## SCK-SERIES Part Number Code

[A]



[B]

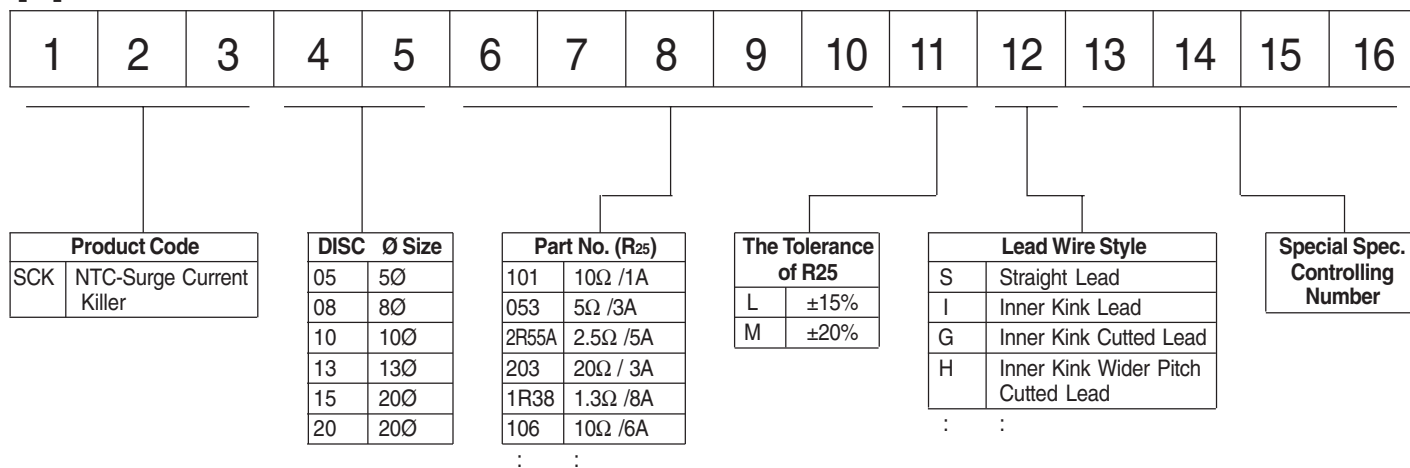

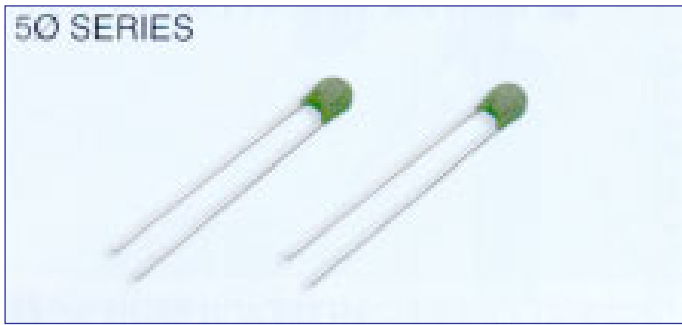

## POWER DERATING CURVE

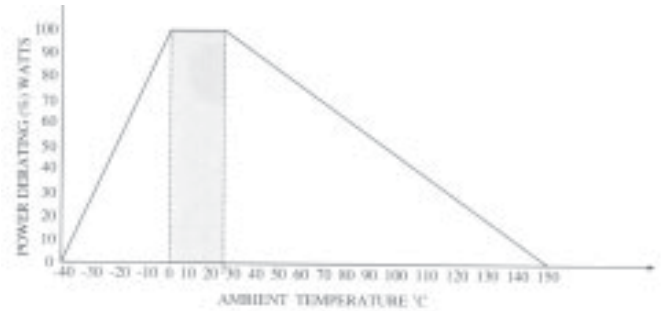

## SPECIFICATION

| Part No  | Zero Power Resistance at 25°C (Ω) | Max. Steady State Current at 25°C (A) | Approx. Resistance at Max. Current at 25°C (mΩ) | Thermal Dissipation Constant (mW/°C) | Thermal Time Constant (Sec.) | Operating Temperature (°C) |
|----------|-----------------------------------|---------------------------------------|---|--------------------------------------|------------------------------|----------------------------|
| SCK-052  | 5                                 | 2                                     | 429   | 14                                   | 17                           | -40~+150                   |
| SCK-101  | 10                                | 1                                     | 1126  | 15                                   | 17                           | -40~+150                   |
| SCK-20X3 | 20                                | 0.3                                   | 5560  | 14                                   | 22                           | -40~+150                   |

## DIMENSION

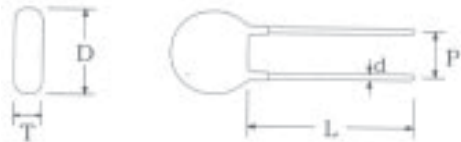

| Disc Ø | D max. | L. min. | d. nor.  | P. nor. | T. max. |
|--------|--------|---------|----------|---------|---------|
| 5      | 6.5    | 31      | 0.8±0.02 | 4±0.6   | 5       |

Unit. mm

## R-T CHARACTERISTIC CURVE

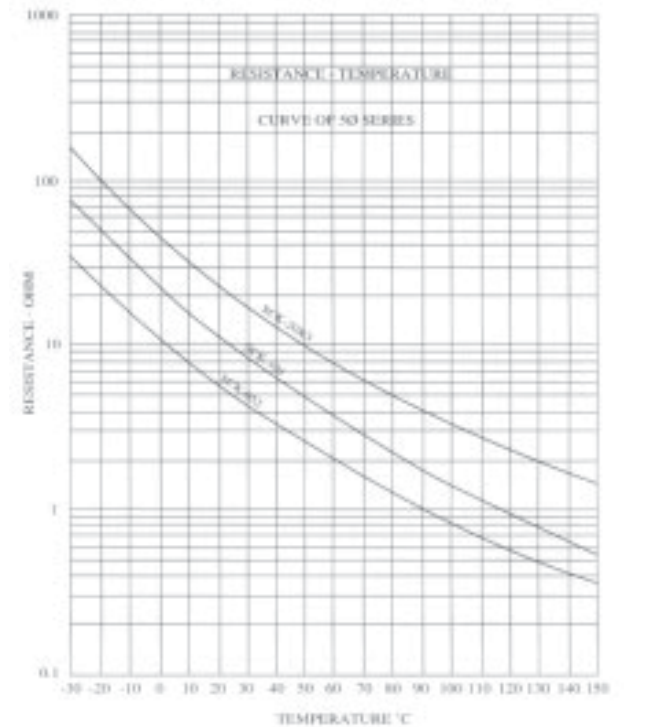

## V-I CHARACTERISTIC CURVE

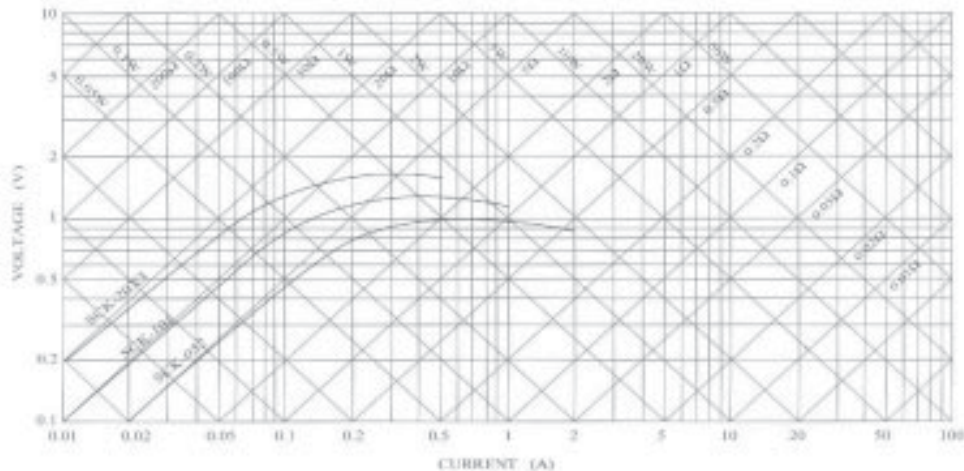



# NTC POWER THERMISTOR 8Ø SERIES

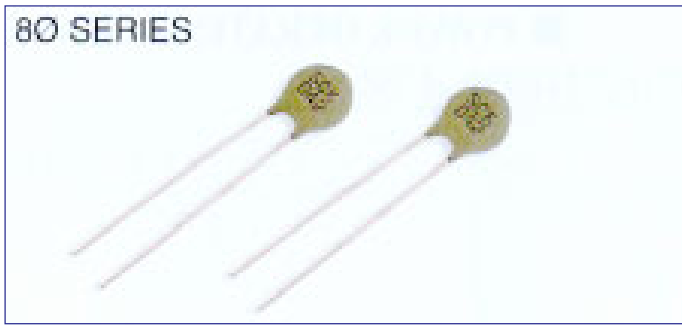

## POWER DERATING CURVE

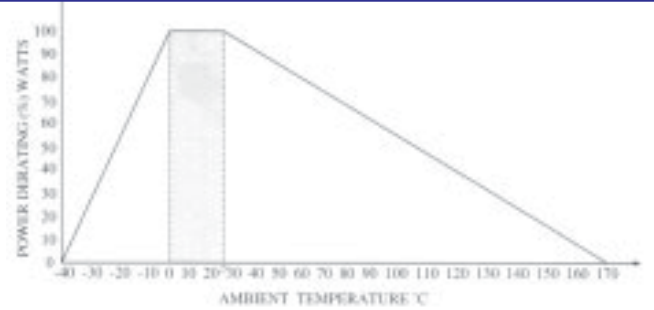

## SPECIFICATION

| Part No | Zero Power Resistance at 25°C (Ω) | Max. Steady State Current at 25°C (A) | Approx. Resistance at Max. Current at 25°C (mΩ) | Thermal Dissipation Constant (mW/°C) | Thermal Time Constant (Sec.) | Operating Temperature (°C) |
|---------|-----------------------------------|---------------------------------------|---|--------------------------------------|------------------------------|----------------------------|
| SCK-042 | 4                                 | 2                                     | 441   | 17                                   | 31                           | -40~+170                   |
| SCK-053 | 5                                 | 3                                     | 261   | 17                                   | 36                           | -40~+170                   |
| SCK-063 | 6                                 | 3                                     | 283   | 17                                   | 38                           | -40~+170                   |
| SCK-082 | 8                                 | 2                                     | 520   | 16                                   | 36                           | -40~+170                   |
| SCK-102 | 10                                | 2                                     | 542   | 17                                   | 38                           | -40~+170                   |
| SCK-152 | 15                                | 2                                     | 548   | 15                                   | 38                           | -40~+170                   |
| SCK-201 | 20                                | 1                                     | 1544  | 17                                   | 41                           | -40~+170                   |

## R-T CHARACTERISTIC CURVE

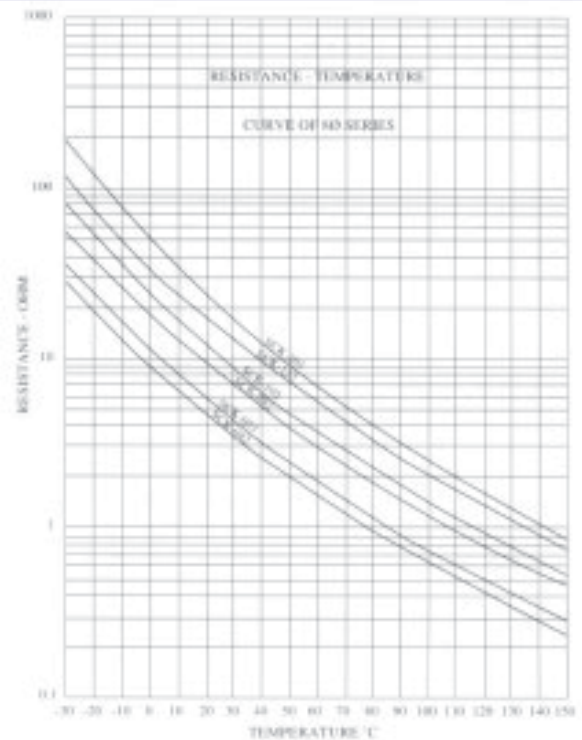

## DIMENSION

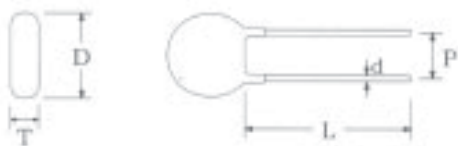

| Disc Ø | D max. | L. min. | d. nor.  | P. nor. | T. max. |
|--------|--------|---------|----------|---------|---------|
| 8      | 9.5    | 31      | 0.8±0.02 | 5±0.8   | 5       |

Unit. mm

## V-I CHARACTERISTIC CURVE

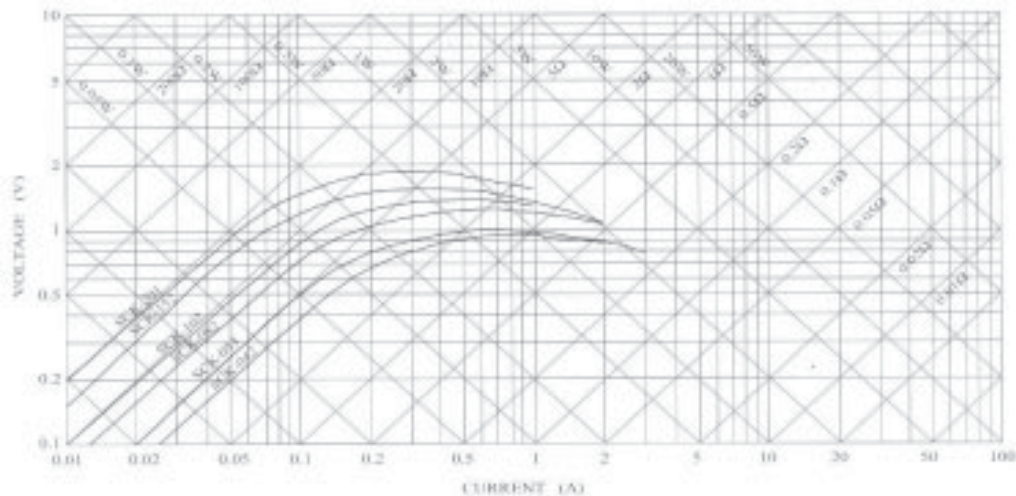



# NTC POWER THERMISTOR 100 SERIES

## 100 SERIES



## POWER DERATING CURVE

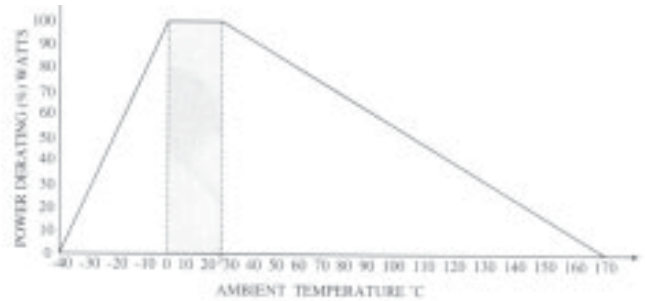

## SPECIFICATION

| Part No   | Zero Power Resistance at 25°C (Ω) | Max. Steady State Current at 25°C (A) | Approx. Resistance at Max. Current at 25°C (mΩ) | Thermal Dissipation Constant (mW/°C) | Thermal Time Constant (Sec.) | Operating Temperature (°C) |
|-----------|-----------------------------------|---------------------------------------|---|--------------------------------------|------------------------------|----------------------------|
| SCK-015   | 1                                 | 5                                     | 91  | 17                                   | 33                           | -40~+170                   |
| SCK-1R55  | 1.5                               | 5                                     | 101   | 17                                   | 34                           | -40~+170                   |
| SCK-2R55A | 2.5                               | 5                                     | 120   | 18                                   | 46                           | -40~+170                   |
| SCK-034   | 3                                 | 4                                     | 156   | 18                                   | 45                           | -40~+170                   |
| SCK-035   | 3                                 | 5                                     | 119   | 18                                   | 45                           | -40~+170                   |
| SCK-044   | 4                                 | 4                                     | 161   | 16                                   | 40                           | -40~+170                   |
| SCK-054   | 5                                 | 4                                     | 180   | 17                                   | 33                           | -40~+170                   |
| SCK-083   | 8                                 | 3                                     | 278   | 17                                   | 43                           | -40~+170                   |
| SCK-103   | 10                                | 3                                     | 297   | 17                                   | 46                           | -40~+170                   |
| SCK-122   | 12                                | 2                                     | 512   | 18                                   | 50                           | -40~+170                   |
| SCK-123   | 12                                | 3                                     | 301   | 18                                   | 50                           | -40~+170                   |
| SCK-133   | 13                                | 3                                     | 356   | 18                                   | 49                           | -40~+170                   |
| SCK-152X  | 15                                | 2.5                                   | 442   | 17                                   | 51                           | -40~+170                   |
| SCK-162   | 16                                | 2                                     | 604   | 18                                   | 55                           | -40~+170                   |
| SCK-162X  | 16                                | 2.5                                   | 442   | 16                                   | 45                           | -40~+170                   |
| SCK-202   | 20                                | 2                                     | 646   | 17                                   | 54                           | -40~+170                   |
| SCK-252   | 25                                | 2                                     | 674   | 17                                   | 52                           | -40~+170                   |
| SCK-302   | 30                                | 2                                     | 700   | 17                                   | 50                           | -40~+170                   |
| SCK-472   | 47                                | 2                                     | 720   | 18                                   | 49                           | -40~+170                   |
| SCK-501X  | 50                                | 1.5                                   | 1170  | 18                                   | 48                           | -40~+170                   |
| SCK-502   | 50                                | 2                                     | 813   | 18                                   | 48                           | -40~+170                   |
| SCK-801   | 80                                | 1                                     | 2236  | 17                                   | 53                           | -40~+170                   |
| SCK-1201  | 120                               | 1                                     | 2406  | 19                                   | 54                           | -40~+170                   |

## R-T CHARACTERISTIC CURVE

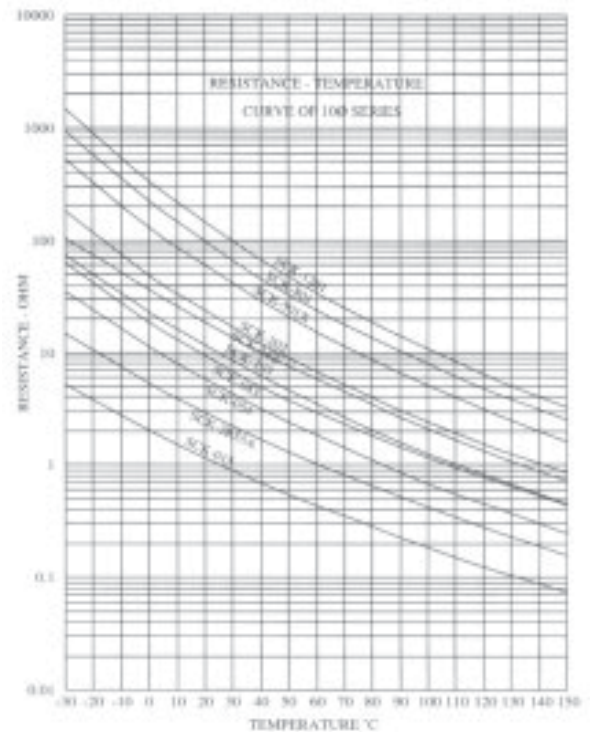

## DIMENSION

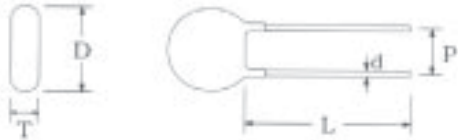

| Disc Ø | D max. | L min. | d. nor.  | P. nor. | T. max. |
|--------|--------|--------|----------|---------|---------|
| 10     | 11.5   | 31     | 0.8±0.02 | 5±0.8   | 5       |

## V-I CHARACTERISTIC CURVE

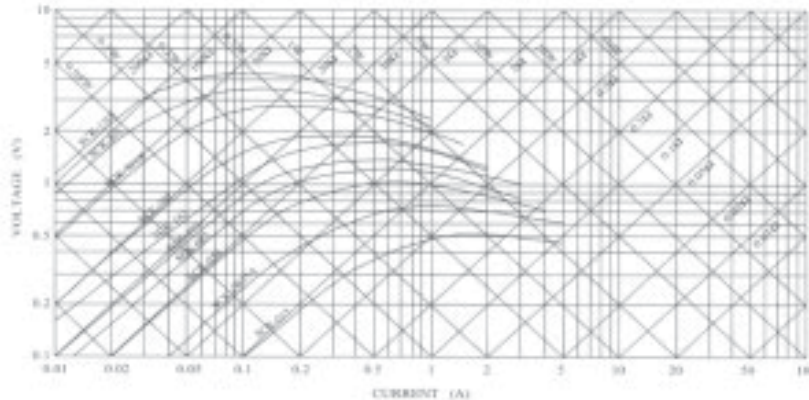





# NTC POWER THERMISTOR 200 SERIES

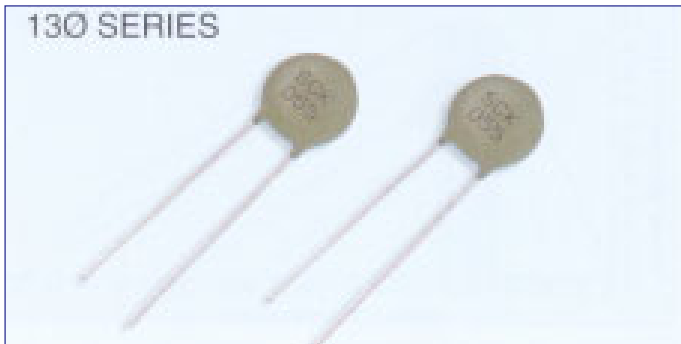

## POWER DERATING CURVE

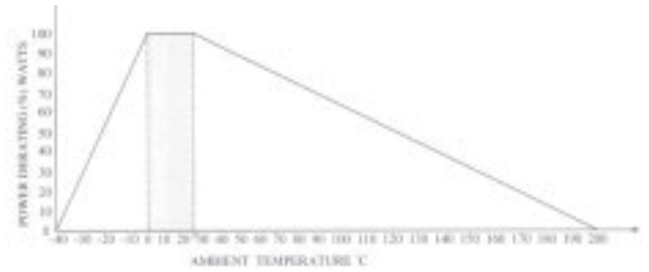

## SPECIFICATION

| Part No  | Zero Power Resistance at 25°C (Ω) | Max. Steady State Current at 25°C (A) | Approx. Resistance at Max. Current at 25°C (mΩ) | Thermal Dissipation Constant (mW/°C) | Thermal Time Constant (Sec.) | Operating Temperature (°C) |
|----------|-----------------------------------|---------------------------------------|---|--------------------------------------|------------------------------|----------------------------|
| SCK-1R37 | 1.3                               | 7                                     | 70  | 17                                   | 49                           | -40~+200                   |
| SCK-2R55 | 2.5                               | 5                                     | 117   | 17                                   | 61                           | -40~+200                   |
| SCK-2R56 | 2.5                               | 6                                     | 94  | 17                                   | 48                           | -40~+200                   |
| SCK-055  | 5                                 | 5                                     | 166   | 18                                   | 75                           | -40~+200                   |
| SCK-084  | 8                                 | 4                                     | 206   | 17                                   | 65                           | -40~+200                   |
| SCK-104  | 10                                | 4                                     | 217   | 17                                   | 66                           | -40~+200                   |
| SCK-124  | 12                                | 4                                     | 217   | 17                                   | 66                           | -40~+200                   |
| SCK-153  | 15                                | 3                                     | 343   | 18                                   | 66                           | -40~+200                   |
| SCK-203  | 20                                | 3                                     | 410   | 20                                   | 76                           | -40~+200                   |

## R-T CHARACTERISTIC CURVE

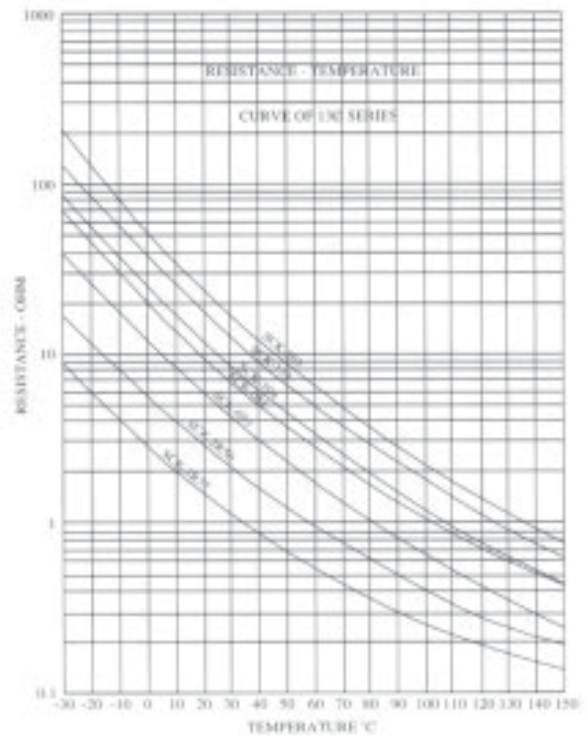

## DIMENSION

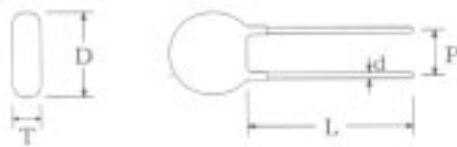

| Disc Ø | D max. | L. min. | d. nor.  | P. nor. | T. max. |
|--------|--------|---------|----------|---------|---------|
| 13     | 14.5   | 30      | 0.8±0.02 | 7.5±1.1 | 6       |

## V-I CHARACTERISTIC CURVE

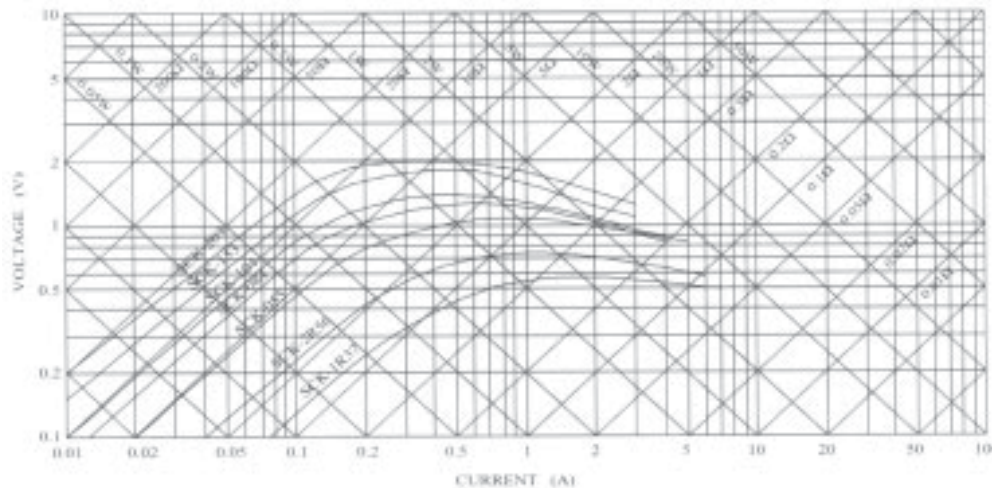



# NTC POWER THERMISTOR 150 SERIES

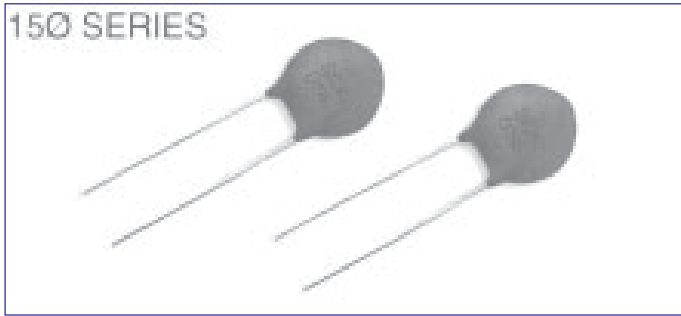

## POWER DERATING CURVE

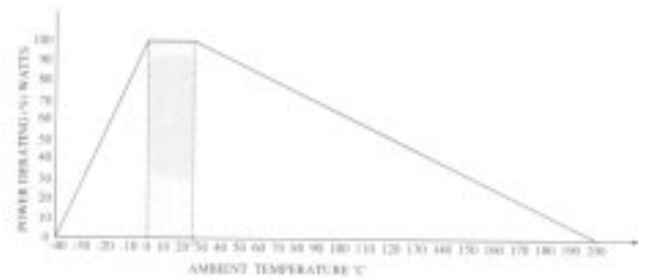

## SPECIFICATION

| Part No  | Zero Power Resistance at 25°C (Ω) | Max. Steady State Current at 25°C (A) | Approx. Resistance at Max. Current at 25°C (mΩ) | Thermal Dissipation Constant (mW/°C) | Thermal Time Constant (Sec.) | Operating Temperature (°C) |
|----------|-----------------------------------|---------------------------------------|---|--------------------------------------|------------------------------|----------------------------|
| SCK-1R38 | 1.3                               | 8                                     | 64  | 21                                   | 59                           | -40~+200                   |
| SCK-1R58 | 1.5                               | 8                                     | 62  | 21                                   | 66                           | -40~+200                   |
| SCK-2R58 | 2.5                               | 8                                     | 75  | 20                                   | 63                           | -40~+200                   |
| SCK-037  | 3                                 | 7                                     | 91  | 21                                   | 73                           | -40~+200                   |
| SCK-046  | 4                                 | 6                                     | 117   | 20                                   | 62                           | -40~+200                   |
| SCK-048  | 4                                 | 8                                     | 87  | 27                                   | 76                           | -40~+200                   |
| SCK-056  | 5                                 | 6                                     | 121   | 20                                   | 66                           | -40~+200                   |
| SCK-057  | 5                                 | 7                                     | 98  | 20                                   | 65                           | -40~+200                   |
| SCK-065  | 6                                 | 5                                     | 159   | 20                                   | 74                           | -40~+200                   |
| SCK-075  | 7                                 | 5                                     | 161   | 20                                   | 79                           | -40~+200                   |
| SCK-078  | 7                                 | 8                                     | 108   | 28                                   | 57                           | -40~+200                   |
| SCK-086  | 8                                 | 6                                     | 130   | 20                                   | 68                           | -40~+200                   |
| SCK-105  | 10                                | 5                                     | 178   | 20                                   | 79                           | -40~+200                   |
| SCK-125  | 12                                | 5                                     | 185   | 19                                   | 59                           | -40~+200                   |
| SCK-152  | 15                                | 2                                     | 704   | 21                                   | 77                           | -40~+200                   |
| SCK-154  | 15                                | 4                                     | 261   | 19                                   | 79                           | -40~+200                   |
| SCK-164  | 16                                | 4                                     | 261   | 19                                   | 79                           | -40~+200                   |
| SCK-204  | 20                                | 4                                     | 283   | 18                                   | 90                           | -40~+200                   |
| SCK-224  | 22                                | 4                                     | 308   | 20                                   | 80                           | -40~+200                   |
| SCK-253  | 25                                | 3                                     | 425   | 21                                   | 76                           | -40~+200                   |
| SCK-403  | 40                                | 3                                     | 511   | 22                                   | 83                           | -40~+200                   |
| SCK-404  | 40                                | 4                                     | 360   | 22                                   | 86                           | -40~+200                   |
| SCK-473  | 47                                | 3                                     | 501   | 20                                   | 77                           | -40~+200                   |
| SCK-802X | 80                                | 2.5                                   | 693   | 19                                   | 71                           | -40~+200                   |
| SCK-1202 | 120                               | 2                                     | 1010  | 19                                   | 65                           | -40~+200                   |

## R-T CHARACTERISTIC CURVE

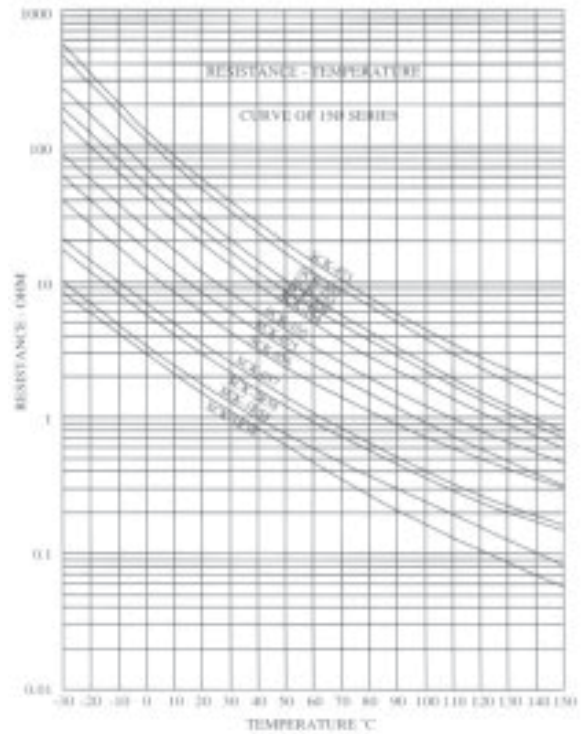

## DIMENSION

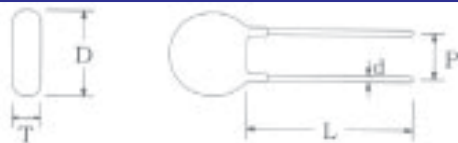

| Disc Ø | D max. | L. min. | d. nor.  | P. nor. | T. max. |
|--------|--------|---------|----------|---------|---------|
| 15     | 16.5   | 29      | 1.0±0.02 | 8±1.2   | 6       |

## V-I CHARACTERISTIC CURVE

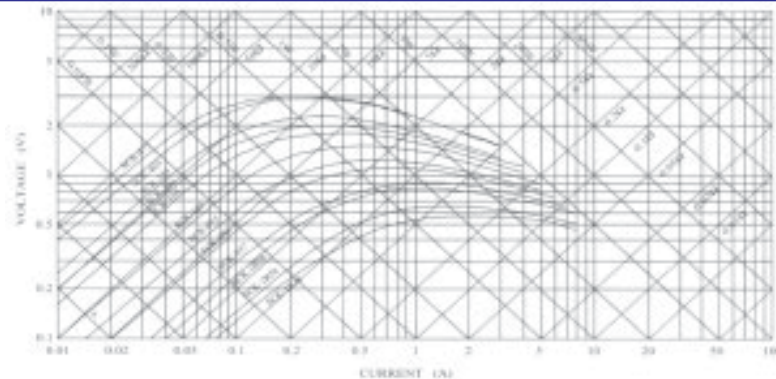



# NTC POWER THERMISTOR 200 SERIES

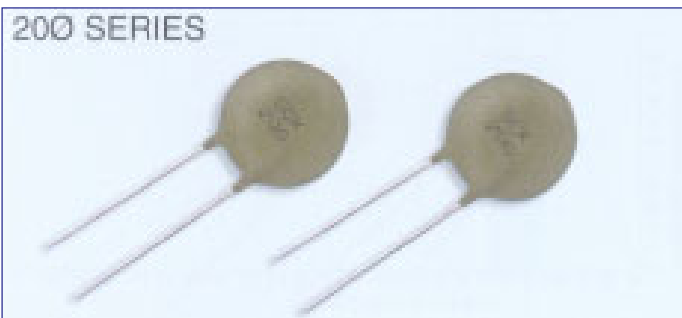

## SPECIFICATION

| Part No   | Zero Power Resistance at 25°C (Ω) | Max. Steady State Current at 25°C (A) | Approx. Resistance at Max. Current at 25°C (mΩ) | Thermal Dissipation Constant (mW/°C) | Thermal Time Constant (Sec.) | Operating Temperature (°C) |
|-----------|-----------------------------------|---------------------------------------|---|--------------------------------------|------------------------------|----------------------------|
| SCK-0R78  | 0.7                               | 8                                     | 59  | 28                                   | 96                           | -40~+200                   |
| SCK-0R715 | 0.7                               | 15                                    | 35  | 29                                   | 122                          | -40~+200                   |
| SCK-0120  | 1                                 | 20                                    | 20  | 25                                   | 73                           | -40~+200                   |
| SCK-0212  | 2                                 | 12                                    | 49  | 29                                   | 101                          | -40~+200                   |
| SCK-2R512 | 2.5                               | 12                                    | 60  | 29                                   | 104                          | -40~+200                   |
| SCK-2R515 | 2.5                               | 15                                    | 46  | 29                                   | 103                          | -40~+200                   |
| SCK-0310  | 3                                 | 10                                    | 63  | 28                                   | 100                          | -40~+200                   |
| SCK-058   | 5                                 | 8                                     | 93  | 28                                   | 101                          | -40~+200                   |
| SCK-0510  | 5                                 | 10                                    | 82  | 29                                   | 123                          | -40~+200                   |
| SCK-0512  | 5                                 | 12                                    | 66  | 29                                   | 124                          | -40~+200                   |
| SCK-106   | 10                                | 6                                     | 173   | 32                                   | 100                          | -40~+200                   |
| SCK-108   | 10                                | 8                                     | 122   | 29                                   | 119                          | -40~+200                   |
| SCK-128   | 12                                | 8                                     | 106   | 24                                   | 130                          | -40~+200                   |
| SCK-138   | 13                                | 8                                     | 106   | 24                                   | 130                          | -40~+200                   |
| SCK-206   | 20                                | 6                                     | 190   | 28                                   | 107                          | -40~+200                   |

## DIMENSION

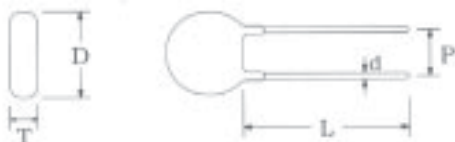

Unit. mm

| Disc Ø | D max. | L. min. | d. nor.  | P. nor. | T. max. |
|--------|--------|---------|----------|---------|---------|
| 20     | 21.5   | 26      | 1.0±0.02 | 8±1.2   | 6       |

## V-I CHARACTERISTIC CURVE

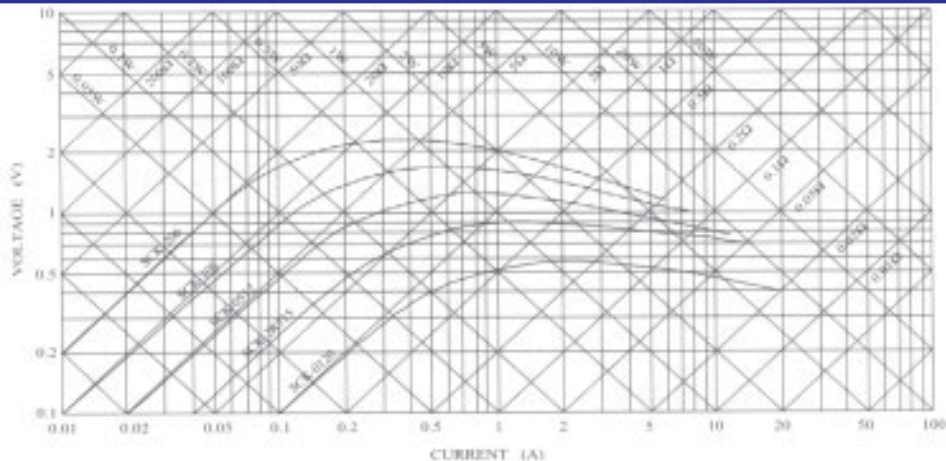

## POWER DERATING CURVE

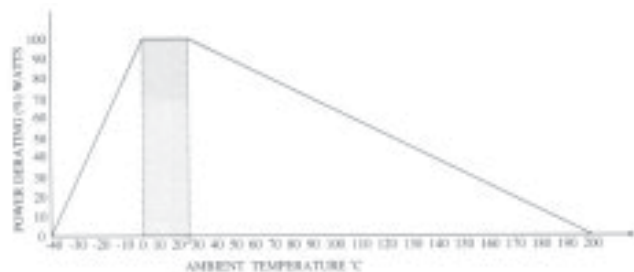

## R-T CHARACTERISTIC CURVE

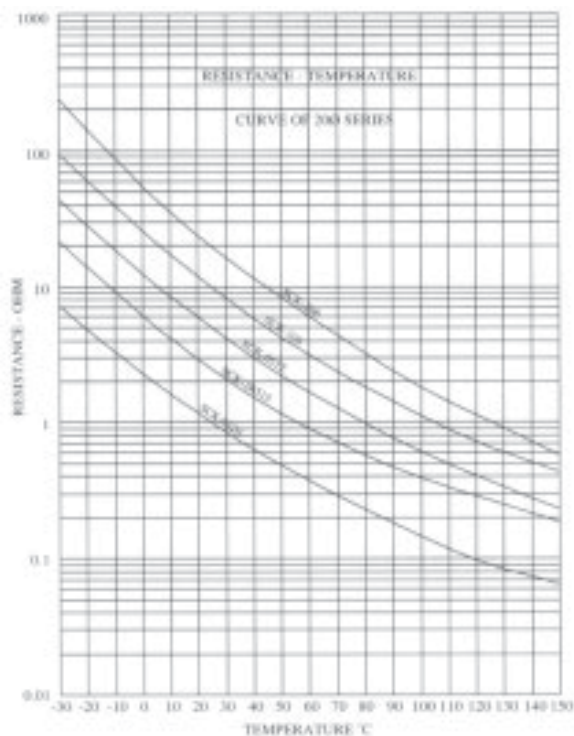



## TTC-SERIES Part Number Code

[A]

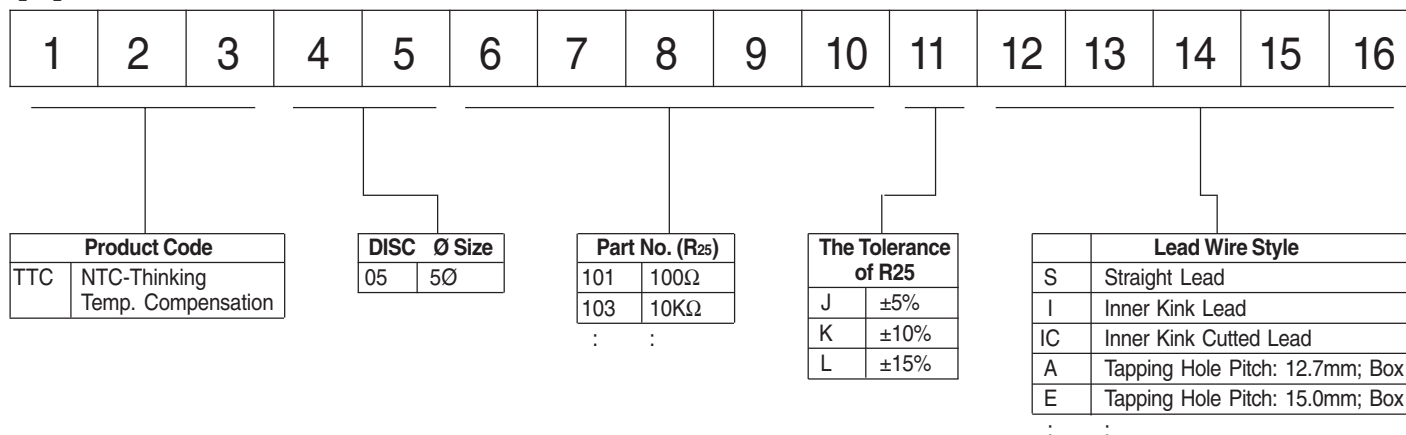

[B]

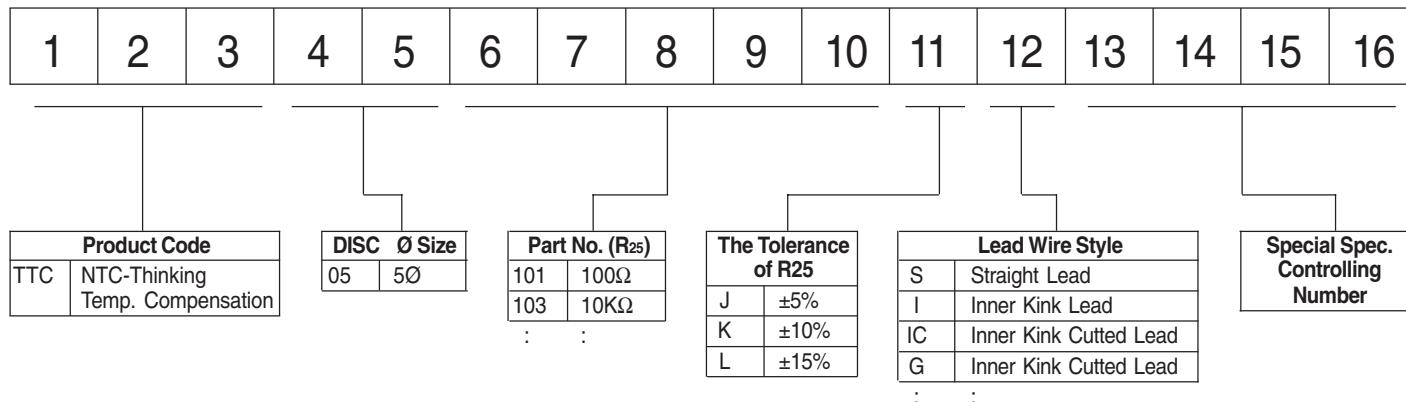





# NTC THERMISTOR TEMPERATURE COMPENSATION



## DIMENSION



Unit. mm

| Disc Ø | D max. | L. min. | d. nor.  | P. nor. | T. max. |
|--------|--------|---------|----------|---------|---------|
| 5      | 6.5    | 31      | 0.5±0.02 | 3.5±0.5 | 5       |



Unit. mm

| Disc Ø | D max. | L. min. | d. nor.  | P. nor. | T. max. |
|--------|--------|---------|----------|---------|---------|
| 5      | 6.5    | 31      | 0.5±0.02 | 5.0±0.8 | 5       |

## SPECIFICATION

| Part No | Zero Power Resistance at 25°C (Ω) | B-Value R25/R50 (K) | Max. Permissible Current at 25°C (mA) | Thermal Dissipation Constant (mW/°C) | Thermal Time Constant (Sec.) | Operating Temperature (°C) |
|---------|-----------------------------------|---------------------|---------------------------------------|--------------------------------------|------------------------------|----------------------------|
| TTC-005 | 5                                 | 2400                | 610                                   | 9                                    | 16                           | -30~+125                   |
| TTC-010 | 10                                | 2800                | 500                                   | 9                                    | 22                           | -30~+125                   |
| TTC-015 | 15                                | 2800                | 390                                   | 8                                    | 19                           | -30~+125                   |
| TTC-020 | 20                                | 2800                | 350                                   | 9                                    | 25                           | -30~+125                   |
| TTC-025 | 25                                | 2900                | 300                                   | 8                                    | 19                           | -30~+125                   |
| TTC-045 | 45                                | 3100                | 270                                   | 9                                    | 23                           | -30~+125                   |
| TTC-050 | 50                                | 3100                | 250                                   | 9                                    | 19                           | -30~+125                   |
| TTC-060 | 60                                | 3100                | 220                                   | 9                                    | 21                           | -30~+125                   |
| TTC-085 | 85                                | 3200                | 180                                   | 9                                    | 22                           | -30~+125                   |
| TTC-090 | 90                                | 3200                | 180                                   | 9                                    | 18                           | -30~+125                   |
| TTC-101 | 100                               | 3200                | 170                                   | 9                                    | 19                           | -30~+125                   |
| TTC-121 | 120                               | 3300                | 145                                   | 8                                    | 20                           | -30~+125                   |
| TTC-151 | 150                               | 3300                | 140                                   | 9                                    | 19                           | -30~+125                   |
| TTC-201 | 200                               | 3500                | 130                                   | 9                                    | 17                           | -30~+125                   |
| TTC-221 | 220                               | 3500                | 125                                   | 9                                    | 20                           | -30~+125                   |
| TTC-251 | 250                               | 3500                | 120                                   | 9                                    | 21                           | -30~+125                   |
| TTC-301 | 300                               | 3800                | 115                                   | 9                                    | 22                           | -30~+125                   |
| TTC-471 | 470                               | 3500                | 95                                    | 9                                    | 28                           | -30~+125                   |
| TTC-501 | 500                               | 3700                | 95                                    | 9                                    | 22                           | -30~+125                   |
| TTC-681 | 680                               | 3800                | 75                                    | 8                                    | 18                           | -30~+125                   |
| TTC-701 | 700                               | 3800                | 75                                    | 9                                    | 17                           | -30~+125                   |

## R-T CHARACTERISTIC CURVE

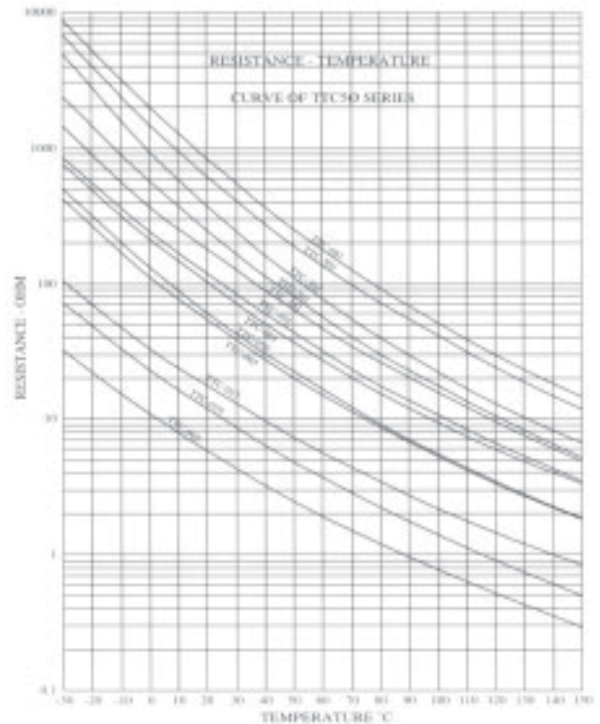

## V-I CHARACTERISTIC CURVE

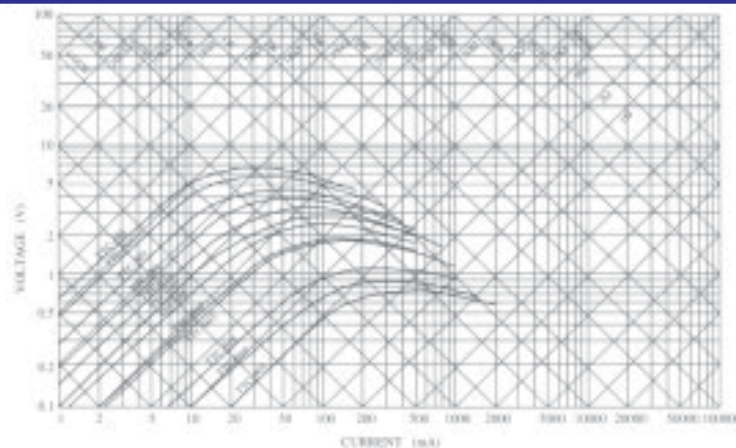



# NTC THERMISTOR TEMPERATURE COMPENSATION

## SPECIFICATION

| Part No | Zero Power Resistance at 25°C (Ω) | B-Value R25/R50 (K) | Max. Permissible Current at 25°C (mA) | Thermal Dissipation Constant (mW/°C) | Thermal Time Constant (Sec.) | Operating Temperature (°C) |
|---------|-----------------------------------|---------------------|---------------------------------------|--------------------------------------|------------------------------|----------------------------|
| TTC-102 | 1                                 | 3800                | 70                                    | 9                                    | 22                           | -30~+125                   |
| TTC-152 | 1.5                               | 3950                | 55                                    | 8                                    | 22                           | -30~+125                   |
| TTC-202 | 2                                 | 4000                | 50                                    | 9                                    | 21                           | -30~+125                   |
| TTC-222 | 2.2                               | 4000                | 50                                    | 9                                    | 21                           | -30~+125                   |
| TTC-252 | 2.5                               | 4000                | 50                                    | 9                                    | 21                           | -30~+125                   |
| TTC-302 | 3                                 | 4000                | 40                                    | 9                                    | 20                           | -30~+125                   |
| TTC-332 | 3.3                               | 4000                | 35                                    | 9                                    | 19                           | -30~+125                   |
| TTC-402 | 4                                 | 4000                | 35                                    | 8                                    | 20                           | -30~+125                   |
| TTC-472 | 4.7                               | 4050                | 30                                    | 8                                    | 21                           | -30~+125                   |
| TTC-502 | 5                                 | 3950                | 30                                    | 9                                    | 21                           | -30~+125                   |
| TTC-602 | 6                                 | 4050                | 30                                    | 8                                    | 22                           | -30~+125                   |
| TTC-682 | 6.8                               | 4050                | 25                                    | 9                                    | 20                           | -30~+125                   |
| TTC-802 | 8                                 | 4050                | 25                                    | 8                                    | 23                           | -30~+125                   |
| TTC-103 | 10                                | 4050                | 20                                    | 8                                    | 21                           | -30~+125                   |
| TTC-123 | 12                                | 4050                | 20                                    | 8                                    | 18                           | -30~+125                   |
| TTC-153 | 15                                | 4150                | 20                                    | 9                                    | 22                           | -30~+125                   |
| TTC-203 | 20                                | 4250                | 20                                    | 9                                    | 23                           | -30~+125                   |
| TTC-303 | 30                                | 4250                | 15                                    | 8                                    | 26                           | -30~+125                   |
| TTC-473 | 47                                | 4300                | 10                                    | 9                                    | 20                           | -30~+125                   |
| TTC-503 | 50                                | 4300                | 10                                    | 9                                    | 17                           | -30~+125                   |
| TTC-104 | 100                               | 4400                | 10                                    | 8                                    | 24                           | -30~+125                   |
| TTC-154 | 150                               | 4500                | 5                                     | 8                                    | 17                           | -30~+125                   |
| TTC-204 | 200                               | 4600                | 5                                     | 9                                    | 15                           | -30~+125                   |
| TTC-224 | 220                               | 4600                | 5                                     | 9                                    | 17                           | -30~+125                   |

## R-T CHARACTERISTIC CURVE

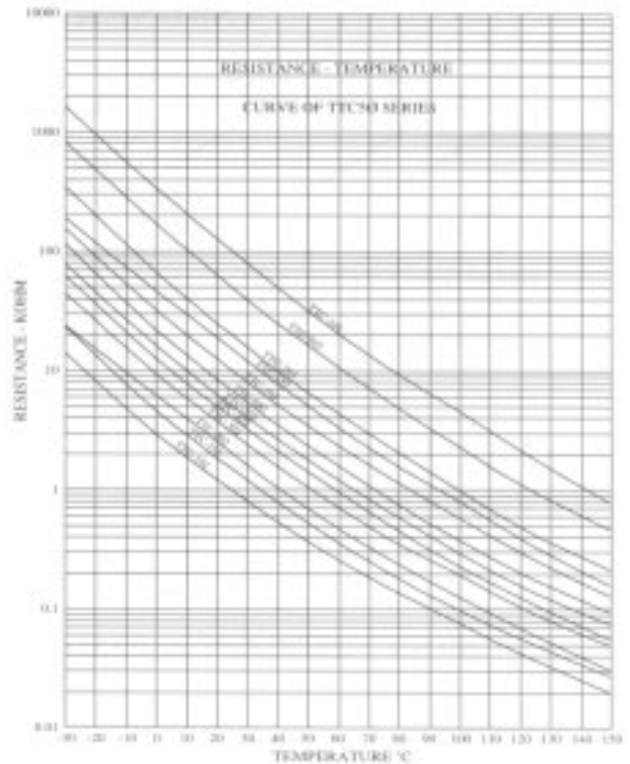

## V-I CHARACTERISTIC CURVE

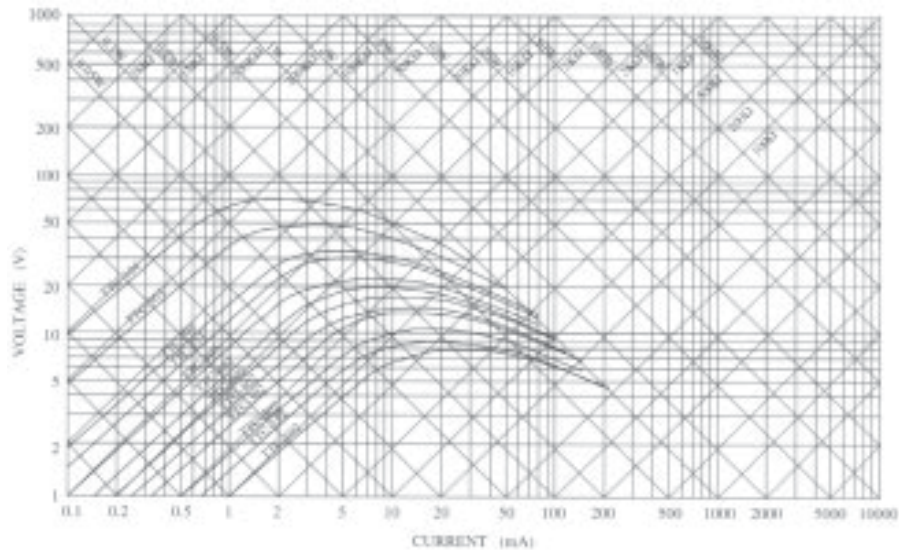

\*REMARK: Tolerance of resistance: ±5%, ±10%, ±15%





# TSM-SERIES Part Number Code

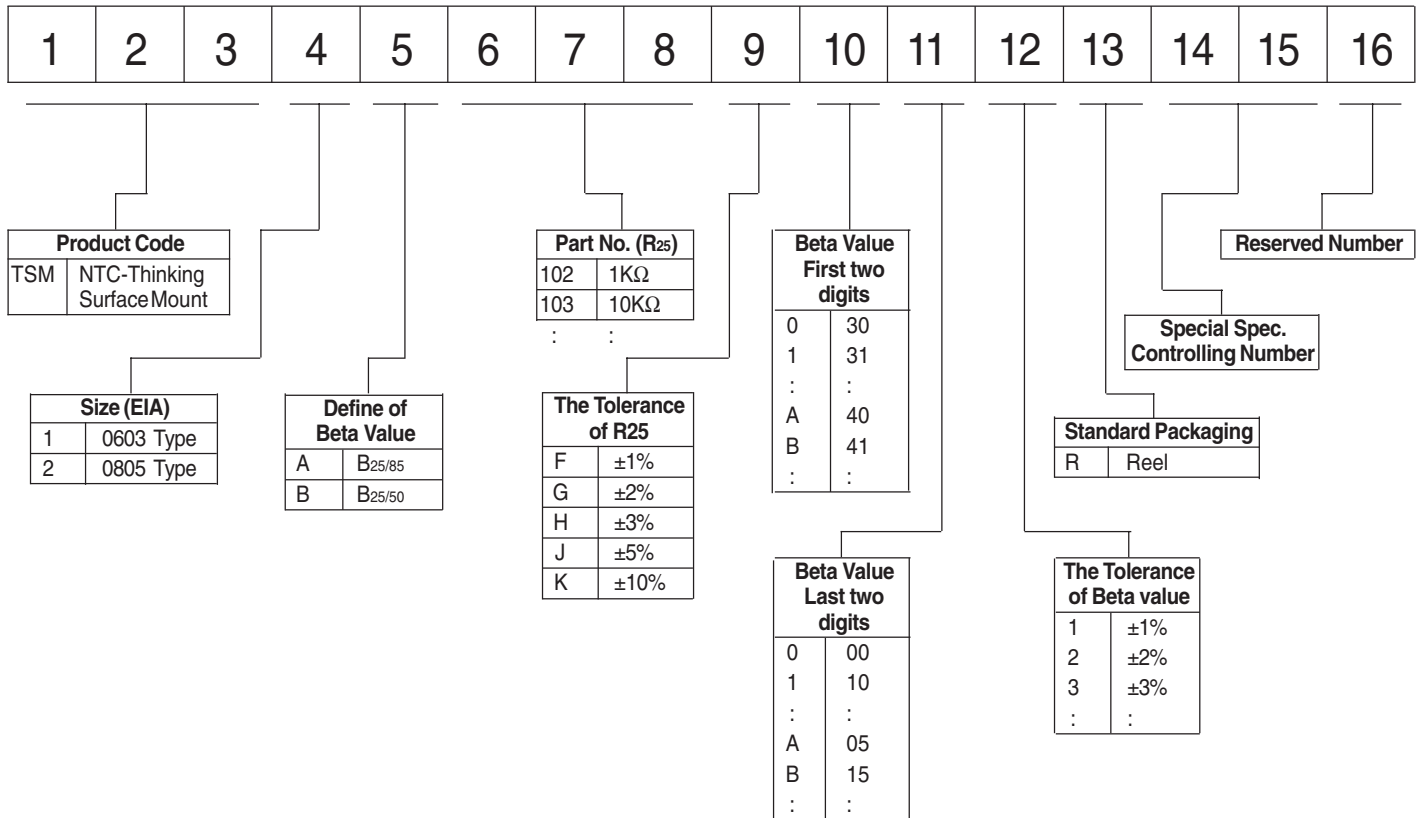

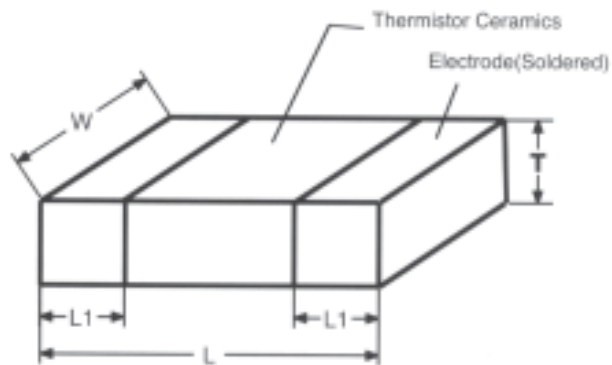

## DIMENSION

Unit.: mm

| Part. No | Size | L         | W         | T       | L1      |
|----------|------|-----------|-----------|---------|---------|
| TSM1     | 0603 | 1.60±0.15 | 0.80±0.15 | 0.95max | 0.10min |
| TSM2     | 0805 | 2.00±0.20 | 1.25±0.20 | 1.20max | 0.20min |

## SPECIFICATION

| Part No   | Zero Power Resistance at 25°C (KΩ) | Tolerance of Resistance (±%) | B Value (K) | Tolerance of B Value (±%) |           |
|-----------|------------------------------------|------------------------------|-------------|---------------------------|-----------|
| TSM1A-103 | 10                                 | 1 - 2 - 3 - 5 - 10           | 25/85       | 3435                      | 1 - 2 - 3 |
| TSM1A-473 | 47                                 | 1 - 2 - 3 - 5 - 10           | 25/85       | 3950                      | 1 - 2 - 3 |
| TSM1A-503 | 50                                 | 1 - 2 - 3 - 5 - 10           | 25/85       | 3950                      | 1 - 2 - 3 |
| TSM1A-683 | 68                                 | 1 - 2 - 3 - 5 - 10           | 25/85       | 4000                      | 1 - 2 - 3 |
| TSM1A-104 | 100                                | 1 - 2 - 3 - 5 - 10           | 25/85       | 4020                      | 1 - 2 - 3 |
| TSM1A-204 | 200                                | 1 - 2 - 3 - 5 - 10           | 25/85       | 3975                      | 1 - 2 - 3 |
| TSM1A-224 | 220                                | 1 - 2 - 3 - 5 - 10           | 25/85       | 3975                      | 1 - 2 - 3 |
| TSM2A-472 | 4.7                                | 1 - 2 - 3 - 5 - 10           | 25/85       | 3435                      | 1 - 2 - 3 |
| TSM2A-502 | 5.0                                | 1 - 2 - 3 - 5 - 10           | 25/85       | 3435                      | 1 - 2 - 3 |
| TSM2A-103 | 10                                 | 1 - 2 - 3 - 5 - 10           | 25/85       | 3435                      | 1 - 2 - 3 |
| TSM2A-473 | 47                                 | 1 - 2 - 3 - 5 - 10           | 25/85       | 4000                      | 1 - 2 - 3 |
| TSM2A-503 | 50                                 | 1 - 2 - 3 - 5 - 10           | 25/85       | 4000                      | 1 - 2 - 3 |
| TSM2A-683 | 68                                 | 1 - 2 - 3 - 5 - 10           | 25/85       | 4020                      | 1 - 2 - 3 |
| TSM2A-104 | 100                                | 1 - 2 - 3 - 5 - 10           | 25/85       | 3975                      | 1 - 2 - 3 |

## R-T CHARACTERISTIC CURVE

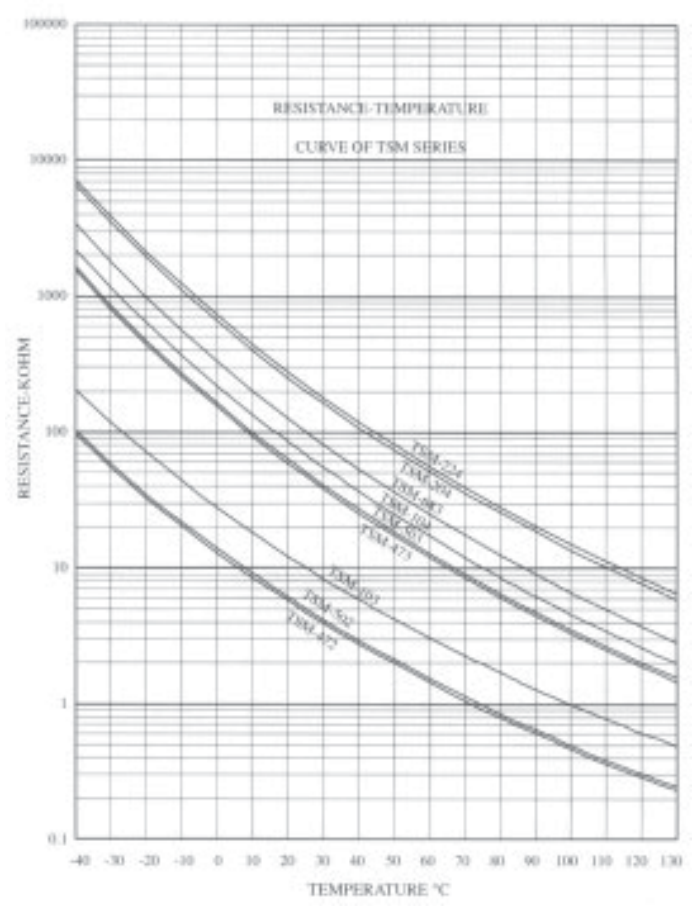

|   |                                    |
|---|------------------------------------|
| Thermal Dissipation Constant              | TSM1 ≥ 0.9mW/°C<br>TSM2 ≥ 1.0mW/°C |
| Thermal Time Constant                     | TSM1 ≤ 5.0 Sec<br>TSM2 ≤ 7.5 Sec   |
| Operating Temperature Range at Zero Power | -40 ~ +125°C                       |





# TTC03-SERIES Part Number Code

|   |   |   |   |   |   |   |   |   |    |    |    |    |    |    |    |
|---|---|---|---|---|---|---|---|---|----|----|----|----|----|----|----|
| 1 | 2 | 3 | 4 | 5 | 6 | 7 | 8 | 9 | 10 | 11 | 12 | 13 | 14 | 15 | 16 |
|---|---|---|---|---|---|---|---|---|----|----|----|----|----|----|----|

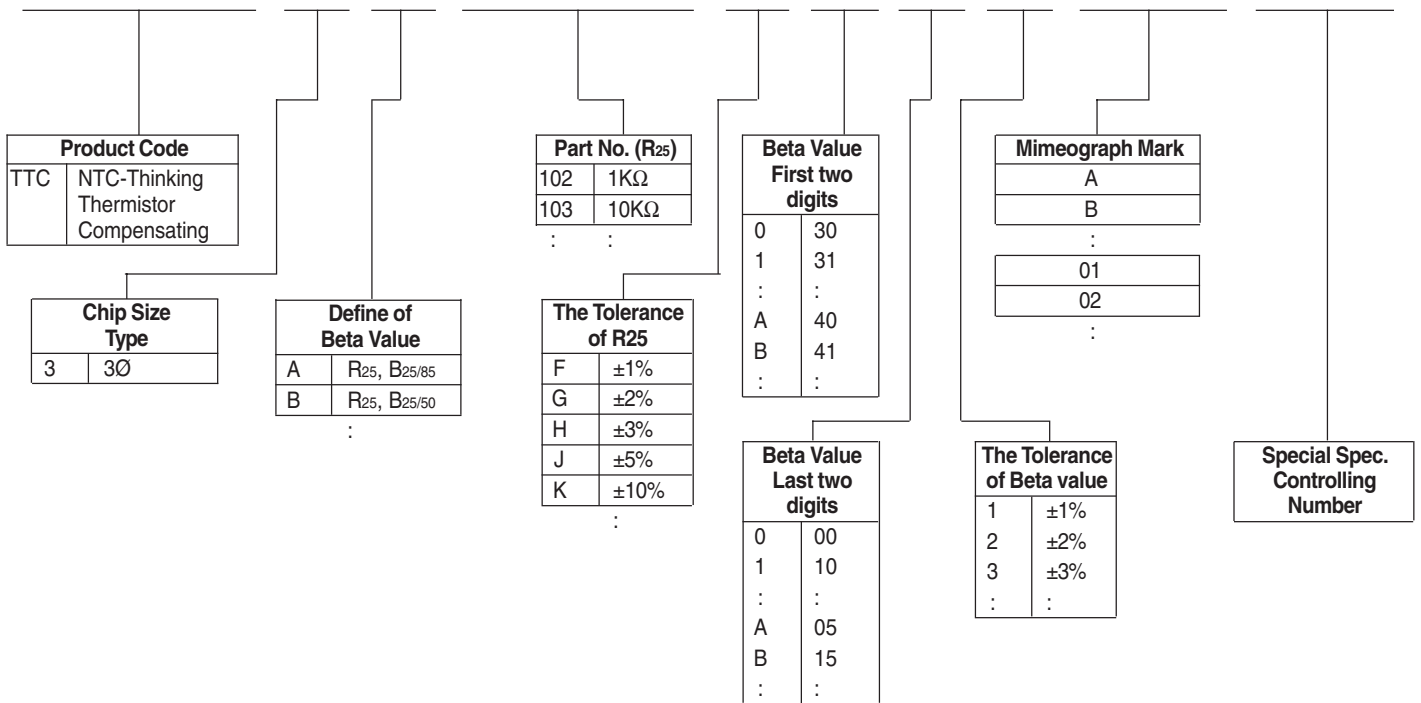

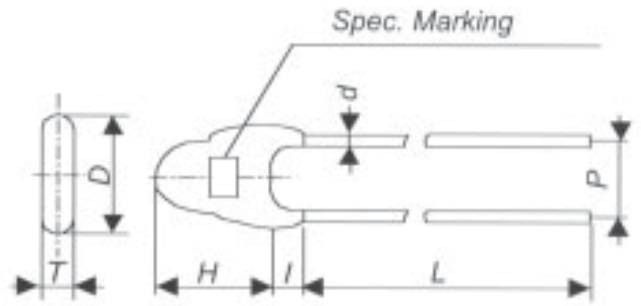

**SPECIFICATION**

| Part No      | Zero Power Resistance at 25°C (KΩ) | Tolerance of Resistance (±%) | B Value (K) | Tolerance of B Value (±%) |     |
|--------------|------------------------------------|------------------------------|-------------|---------------------------|-----|
| TTC3A901-9D2 | 0.9                                | 1 - 2 - 3 - 5 - 10           | 25/85       | 3935                      | 2.0 |
| TTC3A102-9D2 | 1                                  | 1 - 2 - 3 - 5 - 10           | 25/85       | 3935                      | 2.0 |
| TTC3A202-9LA | 2                                  | 1 - 2 - 3 - 5 - 10           | 25/85       | 3977                      | 1.5 |
| TTC3A222-9LA | 2.2                                | 1 - 2 - 3 - 5 - 10           | 25/85       | 3977                      | 1.5 |
| TTC3A272-9LA | 2.7                                | 1 - 2 - 3 - 5 - 10           | 25/85       | 3977                      | 1.5 |
| TTC3A302-9LA | 3                                  | 1 - 2 - 3 - 5 - 10           | 25/85       | 3977                      | 1.5 |
| TTC3A332-9LA | 3.3                                | 1 - 2 - 3 - 5 - 10           | 25/85       | 3977                      | 1.5 |
| TTC3A472-9LA | 4.7                                | 1 - 2 - 3 - 5 - 10           | 25/85       | 3977                      | 1.5 |
| TTC3A502-9LA | 5                                  | 1 - 2 - 3 - 5 - 10           | 25/85       | 3977                      | 1.5 |
| TTC3A682-9LA | 6.8                                | 1 - 2 - 3 - 5 - 10           | 25/85       | 3977                      | 1.5 |
| TTC3A103-4D2 | 10                                 | 1 - 2 - 3 - 5 - 10           | 25/85       | 3435                      | 2.0 |
| TTC3A103-743 | 10                                 | 1 - 2 - 3 - 5 - 10           | 25/85       | 3740                      | 3.0 |
| TTC3A103-9LA | 10                                 | 1 - 2 - 3 - 5 - 10           | 25/85       | 3977                      | 1.5 |
| TTC3B103-B02 | 10                                 | 1 - 2 - 3 - 5 - 10           | 25/50       | 4100                      | 2.0 |
| TTC3A123-743 | 12                                 | 1 - 2 - 3 - 5 - 10           | 25/85       | 3740                      | 3.0 |
| TTC3A153-743 | 15                                 | 1 - 2 - 3 - 5 - 10           | 25/85       | 3740                      | 3.0 |
| TTC3A203-743 | 20                                 | 1 - 2 - 3 - 5 - 10           | 25/85       | 3740                      | 3.0 |
| TTC3A223-743 | 22                                 | 1 - 2 - 3 - 5 - 10           | 25/85       | 3740                      | 3.0 |
| TTC3A333-A9A | 33                                 | 1 - 2 - 3 - 5 - 10           | 25/85       | 4090                      | 1.5 |
| TTC3A473-A9A | 47                                 | 1 - 2 - 3 - 5 - 10           | 25/85       | 4090                      | 1.5 |
| TTC3A683-B92 | 68                                 | 1 - 2 - 3 - 5 - 10           | 25/85       | 4190                      | 2.0 |
| TTC3A104-B92 | 100                                | 1 - 2 - 3 - 5 - 10           | 25/85       | 4190                      | 2.0 |
| TTC3A154-D7B | 150                                | 1 - 2 - 3 - 5 - 10           | 25/85       | 4370                      | 2.5 |
| TTC3A224-D7B | 220                                | 1 - 2 - 3 - 5 - 10           | 25/85       | 4370                      | 2.5 |
| TTC3A334-F73 | 330                                | 1 - 2 - 3 - 5 - 10           | 25/85       | 4570                      | 3.0 |
| TTC3A474-F73 | 470                                | 1 - 2 - 3 - 5 - 10           | 25/85       | 4570                      | 3.0 |
| TTC3B474-J05 | 470                                | 1 - 2 - 3 - 5 - 10           | 25/50       | 5200                      | 5.0 |

**DIMENSION**

Unit.: mm

| Dmax | Tmax | Hmax | lmax | Lmin | Pnol.    | dnol     |
|------|------|------|------|------|----------|----------|
| 4    | 3    | 5    | 3    | 30   | 2.54±1.0 | 0.5±0.02 |

**R-T CHARACTERISTIC CURVE**

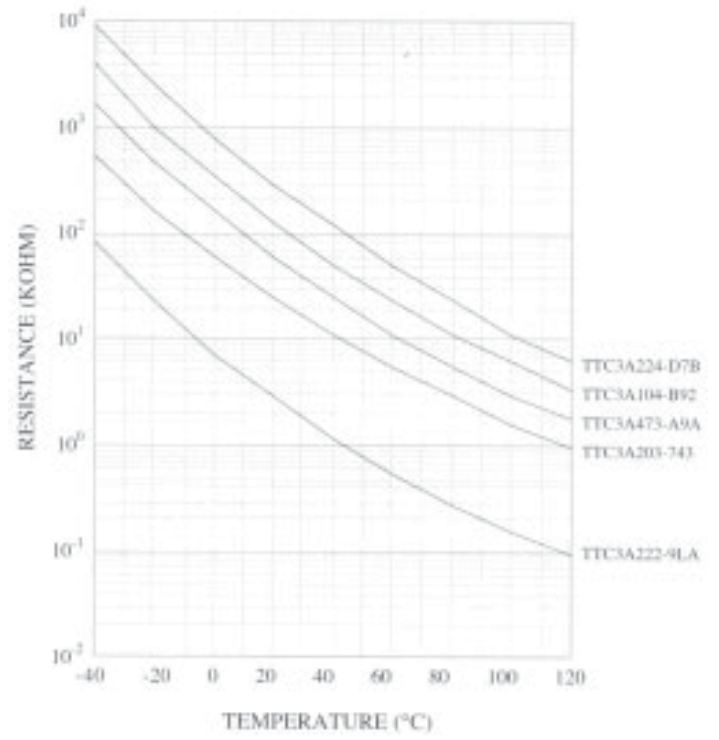

|   |              |
|---|--------------|
| Thermal Dissipation Constant              | ≥ 5mW/°C     |
| Thermal Time Constant                     | ≤ 11 Sec     |
| Maximum Dissipation                       | 250mW        |
| Operating Temperature Range at Zero Power | -40 to 125°C |
| at Maximum Power                          | 0 to 55°C    |



# TCF-SERIES Part Number Code

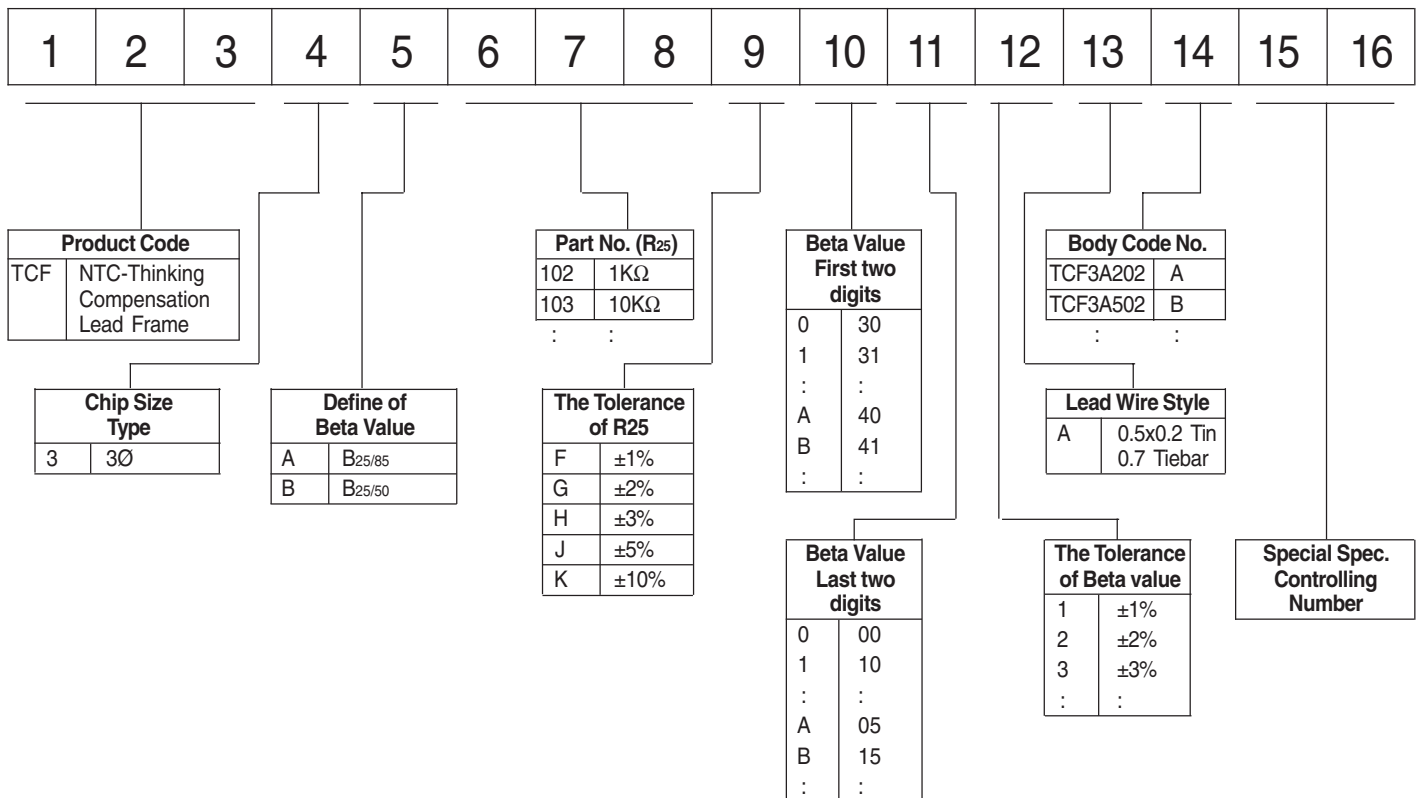

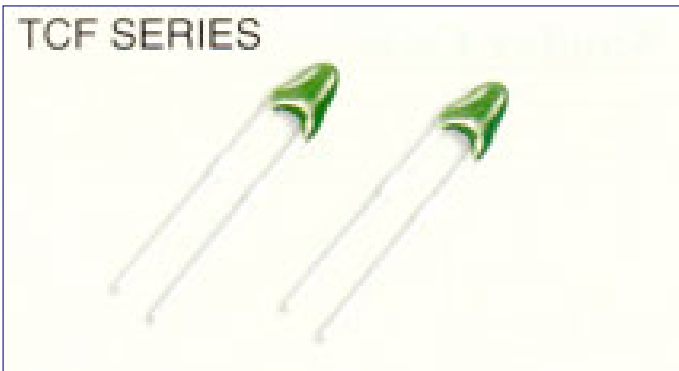

**DIMENSION**

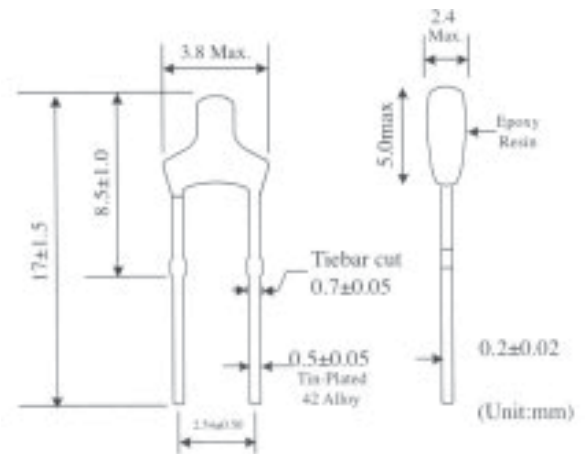

**SPECIFICATION**

| Part No | Zero Power Resistance at 25°C (KΩ) | Tolerance of at 25°C (±%) | B Value (K) | Tolerance of B Value (±%) | Code of Part No |
|---------|------------------------------------|---------------------------|-------------|---------------------------|-----------------|
| TCF-202 | 2                                  | 1 - 2 - 3 - 5 - 10        | 25/85       | 3182                      | 1 - 2 - 3 - 5 A |
| TCF-502 | 5                                  | 1 - 2 - 3 - 5 - 10        | 25/85       | 3324                      | 1 - 2 - 3 - 5 B |
| TCF-103 | 10                                 | 1 - 2 - 3 - 5 - 10        | 25/85       | 3435                      | 1 - 2 - 3 - 5   |
| TCF-123 | 12                                 | 1 - 2 - 3 - 5 - 10        | 25/85       | 3470                      | 1 - 2 - 3 - 5 E |
| TCF-203 | 20                                 | 1 - 2 - 3 - 5 - 10        | 25/85       | 4013                      | 1 - 2 - 3 - 5 F |
| TCF-303 | 30                                 | 1 - 2 - 3 - 5 - 10        | 25/85       | 4090                      | 1 - 2 - 3 - 5 G |
| TCF-333 | 33                                 | 1 - 2 - 3 - 5 - 10        | 25/85       | 4090                      | 1 - 2 - 3 - 5 H |
| TCF-473 | 47                                 | 1 - 2 - 3 - 5 - 10        | 25/85       | 4090                      | 1 - 2 - 3 - 5 I |
| TCF-503 | 50                                 | 1 - 2 - 3 - 5 - 10        | 25/85       | 4060                      | 1 - 2 - 3 - 5 J |
| TCF-104 | 100                                | 1 - 2 - 3 - 5 - 10        | 25/85       | 4190                      | 1 - 2 - 3 - 5 K |

**R-T CHARACTERISTIC CURVE**

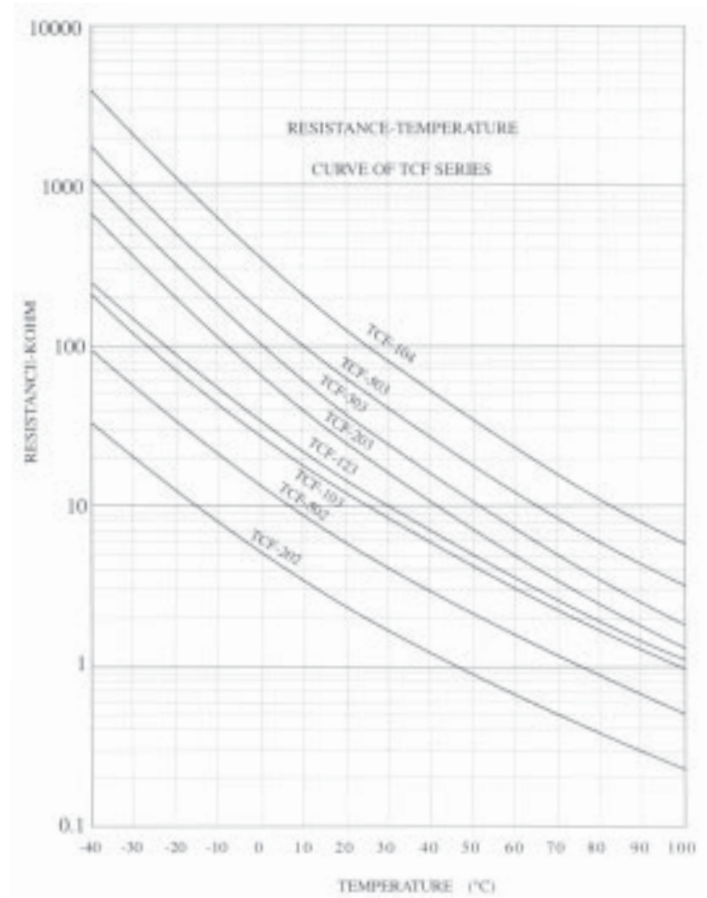

|   |              |
|---|--------------|
| Thermal Dissipation Constant              | 2 mW/°C      |
| Thermal Time Constant                     | 12 Sec       |
| Operating Temperature Range at Zero Power | -40 ~ +100°C |







# DHT-SERIES Part Number Code

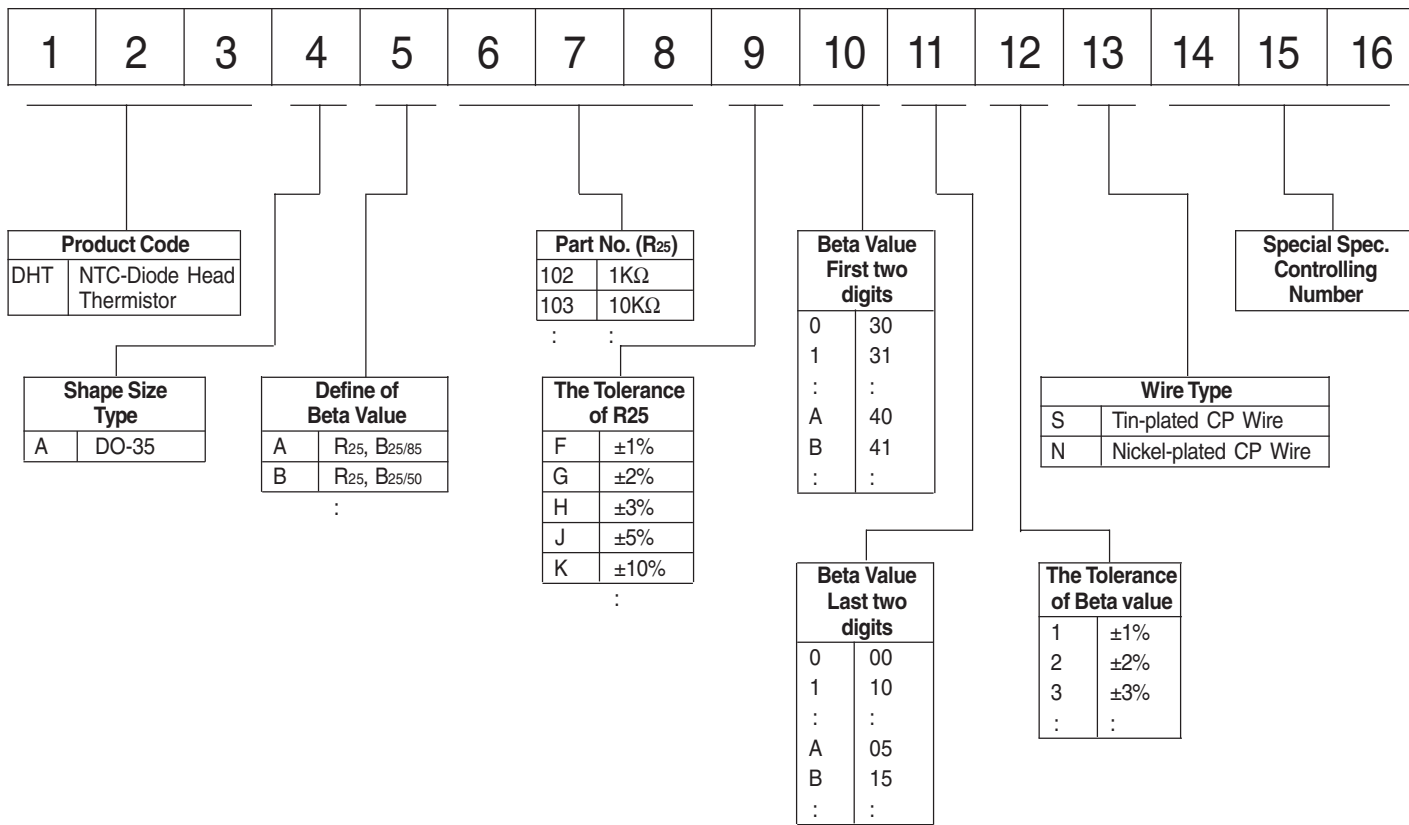



## DIMENSION

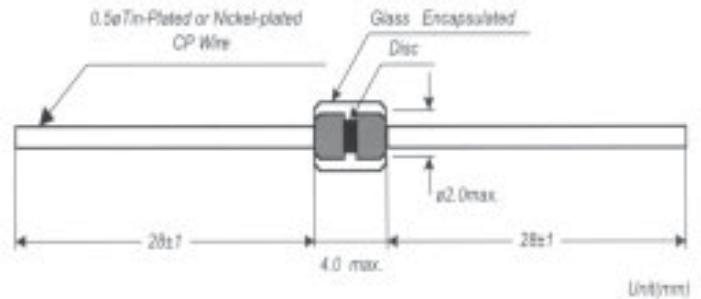

## SPECIFICATION

| Part No      | Zero Power Resistance at 25°C (KΩ) | Tolerance of Resistance (±%) | B Value (K) | Tolerance of B Value (±%) |     |
|--------------|------------------------------------|------------------------------|-------------|---------------------------|-----|
| DHTAB502-552 | 5                                  | 1 - 2 - 3 - 5 - 10           | 25/50       | 3550                      | 2.0 |
| DHTAB103-552 | 10                                 | 1 - 2 - 3 - 5 - 10           | 25/50       | 3550                      | 2.0 |
| DHTAB103-952 | 10                                 | 1 - 2 - 3 - 5 - 10           | 25/50       | 3950                      | 2.0 |
| DHTAA103-4D2 | 10                                 | 1 - 2 - 3 - 5 - 10           | 25/85       | 3435                      | 2.0 |
| DHTAA103-272 | 10                                 | 1 - 2 - 3 - 5 - 10           | 25/85       | 3270                      | 2.0 |
| DHTAA103-702 | 10                                 | 1 - 2 - 3 - 5 - 10           | 25/85       | 3700                      | 2.0 |
| DHTAB103-472 | 10                                 | 1 - 2 - 3 - 5 - 10           | 25/50       | 3470                      | 2.0 |
| DHTAA103-9L2 | 10                                 | 1 - 2 - 3 - 5 - 10           | 25/85       | 3977                      | 2.0 |
| DHTAB203-952 | 20                                 | 1 - 2 - 3 - 5 - 10           | 25/50       | 3950                      | 2.0 |
| DHTAB473-952 | 47                                 | 1 - 2 - 3 - 5 - 10           | 25/50       | 3950                      | 2.0 |
| DHTAB503-952 | 50                                 | 1 - 2 - 3 - 5 - 10           | 25/50       | 3950                      | 2.0 |
| DHTAB104-952 | 100                                | 1 - 2 - 3 - 5 - 10           | 25/50       | 3950                      | 2.0 |
| DHTAB104-A02 | 100                                | 1 - 2 - 3 - 5 - 10           | 25/50       | 4000                      | 2.0 |
| DHTAA104-9L2 | 100                                | 1 - 2 - 3 - 5 - 10           | 25/85       | 3977                      | 2.0 |
| DHTAA104-D02 | 100                                | 1 - 2 - 3 - 5 - 10           | 25/85       | 4300                      | 2.0 |
| DHTAB303-952 | 30                                 | 1 - 2 - 3 - 5 - 10           | 25/50       | 3950                      | 2.0 |

## R-T CHARACTERISTIC CURVE

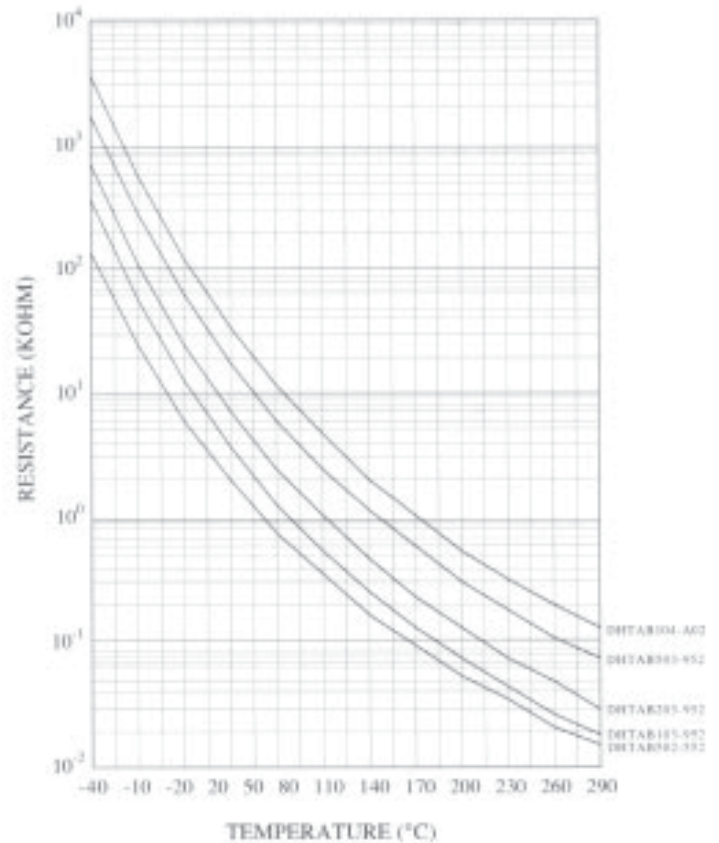

|   |                            |               |
|---|----------------------------|---------------|
| Thermal Dissipation Constant              |                            | > 2mW/°C      |
| Thermal Time Constant                     |                            | < 10sec       |
| Operating Temperature Range at Zero Power | 0.5ø Tin-plated CP wire    | -40 to +200°C |
| Operating Temperature Range at Zero Power | 0.5ø Nickel-plated CP wire | -40 to +300°C |



# TTF-SERIES Part Number Code

|   |   |   |   |   |   |   |   |   |    |    |    |    |    |    |    |
|---|---|---|---|---|---|---|---|---|----|----|----|----|----|----|----|
| 1 | 2 | 3 | 4 | 5 | 6 | 7 | 8 | 9 | 10 | 11 | 12 | 13 | 14 | 15 | 16 |
|---|---|---|---|---|---|---|---|---|----|----|----|----|----|----|----|

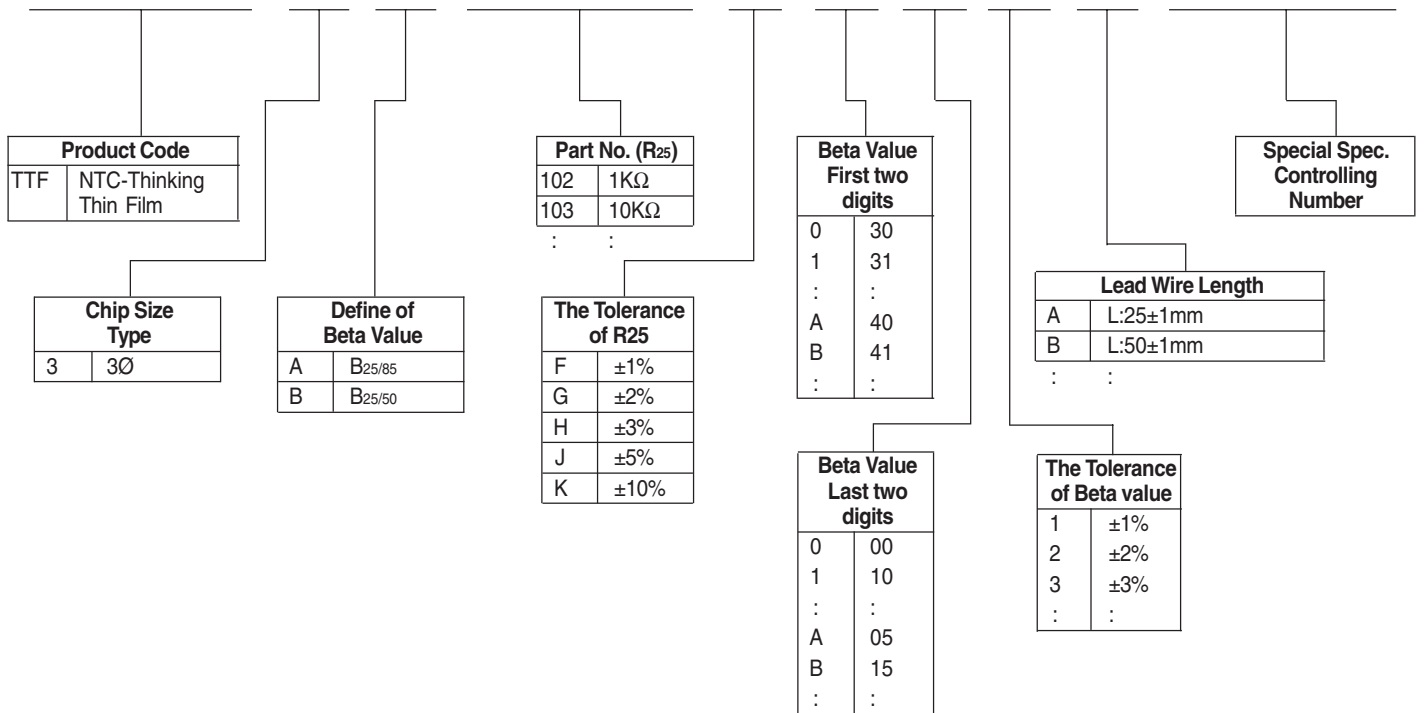



**DIMENSION**

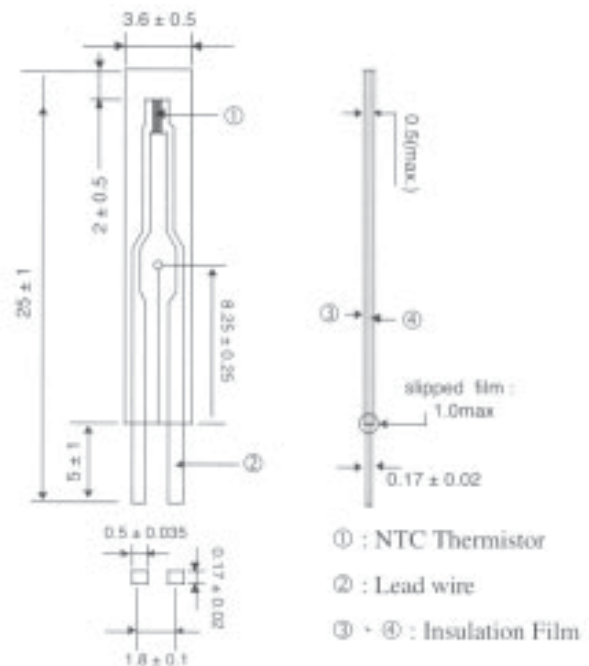

**SPECIFICATION**

| Part No | Zero Power Resistance at 25°C (KΩ) | Tolerance of Resistance (±%) | B Value (K) | Tolerance of B Value (±%) |
|---------|------------------------------------|------------------------------|-------------|---------------------------|
| TTF-103 | 10                                 | 1 - 2 - 3 - 5 - 10           | 25/85 3435  | 1 - 2 - 3                 |

|   |              |
|---|--------------|
| Thermal Dissipation Constant (nor.)       | 0.7 mW/°C    |
| Thermal Time Constant (nor.)              | 5 Sec        |
| Operating Temperature Range at Zero Power | -40 ~ +100°C |

**R-T CHARACTERISTIC CURVE**

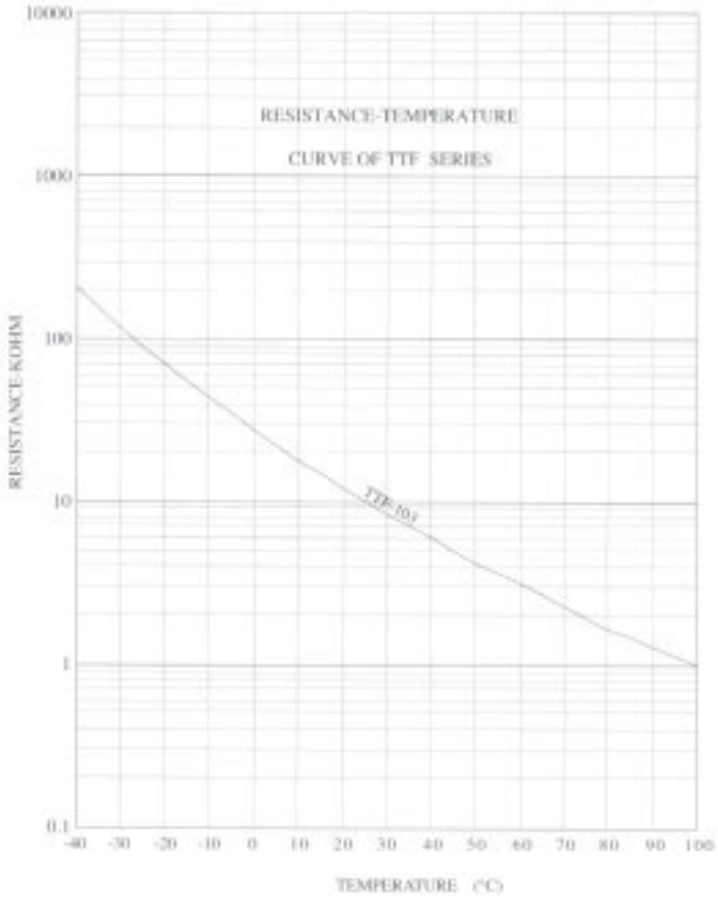





## TTS-SERIES Part Number Code

|   |   |   |   |   |   |   |   |   |    |    |    |    |    |    |    |
|---|---|---|---|---|---|---|---|---|----|----|----|----|----|----|----|
| 1 | 2 | 3 | 4 | 5 | 6 | 7 | 8 | 9 | 10 | 11 | 12 | 13 | 14 | 15 | 16 |
|---|---|---|---|---|---|---|---|---|----|----|----|----|----|----|----|

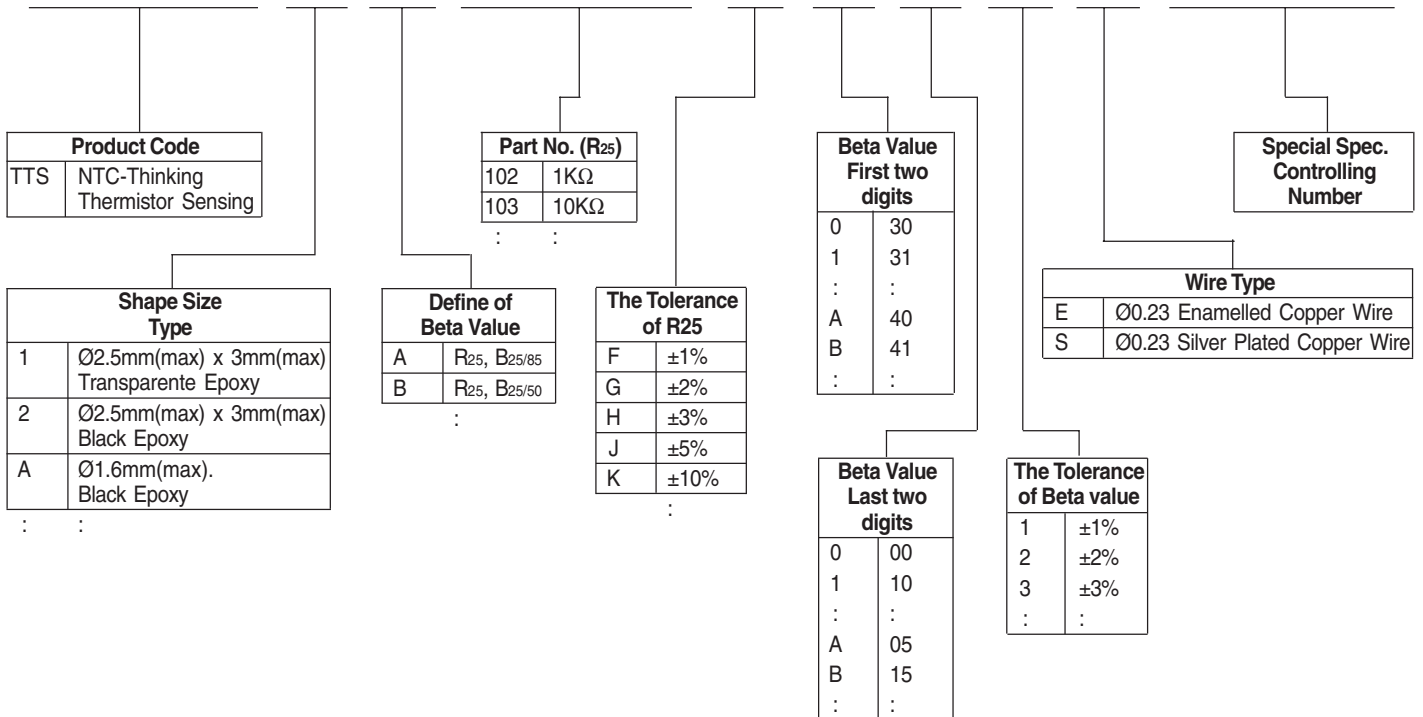



**TTS SERIES**

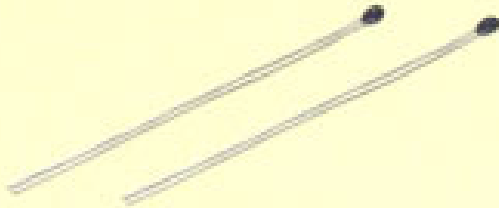

**DIMENSION**

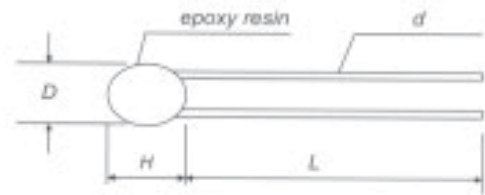

Unit.: mm

| Wire      | Dmax | Nmax | Lmin | dnom |
|-----------|------|------|------|------|
| Ag plated | 2.5  | 3    | 40   | 0.25 |
| Enamelled | 2.5  | 3    | 80   | 0.25 |
| Manganese | 1.6  | 3    | 80   | 0.23 |

**SPECIFICATION**

| Part No      | Zero Power Resistance at 25°C (KW) | Tolerance of Resistance (±%) | B Value (K) | Tolerance of B Value (±%) |     |
|--------------|------------------------------------|------------------------------|-------------|---------------------------|-----|
| TTS2B502-272 | 5                                  | 1 - 2 - 3 - 5 - 10           | 25/50       | 3270                      | 2.0 |
| TTS2B502-472 | 5                                  | 1 - 2 - 3 - 5 - 10           | 25/50       | 3470                      | 2.0 |
| TTS2B502-652 | 5                                  | 1 - 2 - 3 - 5 - 10           | 25/50       | 3650                      | 2.0 |
| TTS2B502-952 | 5                                  | 1 - 2 - 3 - 5 - 10           | 25/50       | 3950                      | 2.0 |
| TTS2B103-382 | 10                                 | 1 - 2 - 3 - 5 - 10           | 25/50       | 3380                      | 2.0 |
| TTS2B103-472 | 10                                 | 1 - 2 - 3 - 5 - 10           | 25/50       | 3470                      | 2.0 |
| TTS2B103-952 | 10                                 | 1 - 2 - 3 - 5 - 10           | 25/50       | 3950                      | 2.0 |
| TTS2A103-4D2 | 10                                 | 1 - 2 - 3 - 5 - 10           | 25/85       | 3435                      | 2.0 |
| TTS2A103-9L2 | 10                                 | 1 - 2 - 3 - 5 - 10           | 25/85       | 3977                      | 2.0 |
| TTS2B203-952 | 20                                 | 1 - 2 - 3 - 5 - 10           | 25/50       | 3950                      | 2.0 |
| TTS2A203-4D2 | 20                                 | 1 - 2 - 3 - 5 - 10           | 25/85       | 3435                      | 2.0 |
| TTS2B303-852 | 30                                 | 1 - 2 - 3 - 5 - 10           | 25/50       | 3850                      | 2.0 |
| TTS2A303-952 | 30                                 | 1 - 2 - 3 - 5 - 10           | 25/85       | 3950                      | 2.0 |
| TTS2B503-952 | 50                                 | 1 - 2 - 3 - 5 - 10           | 25/50       | 3950                      | 2.0 |
| TTS2A833-AB2 | 83                                 | 1 - 2 - 3 - 5 - 10           | 25/85       | 4015                      | 2.0 |
| TTS2B104-D02 | 100                                | 1 - 2 - 3 - 5 - 10           | 25/50       | 4100                      | 2.0 |
| TTS2A503-4D2 | 50                                 | 1 - 2 - 3 - 5 - 10           | 25/85       | 3435                      | 2.0 |
| TTS2A504-C72 | 500                                | 2 - 3 - 5 - 10               | 25/85       | 4270                      | 2.0 |

**R-T CHARACTERISTIC CURVE**

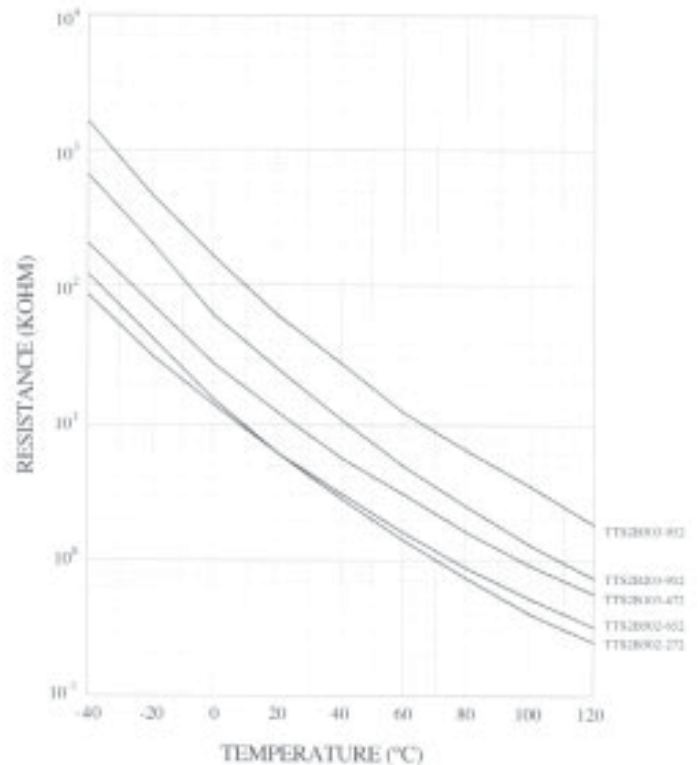

Thermal Dissipation Constant > 1.0mW/°C

Thermal Time Constant < 10 Sec

Operating Temperature Range at Zero Power -40 ~ +125°C

